

*AV Control Stereo Receiver*

**Technics®**

**SA-AX730**  
**SA-AX530**

Operating Instructions

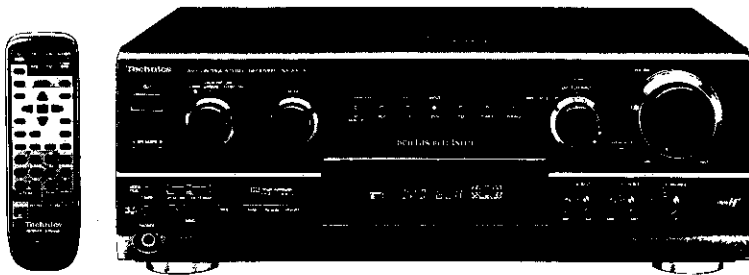

The photographs show SA-AX730.



Before connecting, operating or adjusting this product, please read these instructions completely. Please save this manual.

GC GN

RQT4774-L

## Supplied accessories

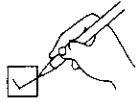

Please check and identify the supplied accessories.

- AC power supply cord (1 pc.)

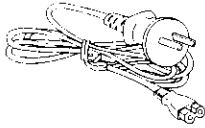

(For Australia and N.Z.)

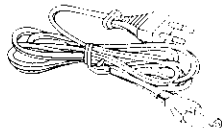

(For others)

- Power plug adaptor (1 pc.)

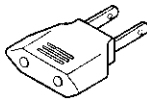

(For areas except Australia and N.Z.)

- AM loop antenna set
- AM loop antenna (1 pc.)
  - AM loop antenna holder (1 pc.)
  - Screw (1 pc.)

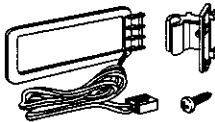

- FM indoor antenna (1 pc.)

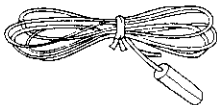

- Antenna plug (1 pc.)

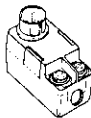

- Batteries (2 pcs.)

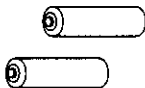

- Remote control transmitter (1 pc.)



(EUR646497)

## Dear Customer

Thank you for purchasing this product.  
For optimum performance and safety, please read these instructions carefully.

These operating instructions are applicable to models SA-AX730 and SA-AX530, however, are intended primarily for model SA-AX730.

(For areas except Australia and N.Z.)

### CAUTION

The AC voltage is different according to the area.

Be sure to set the power voltage in your area before use.

(For details, please refer to the page 8, 10.)

## Table of contents

Suggestions for safety .....	3
Surround guide .....	4
Concerning the remote control .....	5
Front panel controls .....	6
Equipment connections .....	8
SA-AX730 .....	8
SA-AX530 .....	10
Antenna connections .....	12
Speaker connections .....	15
<b>Basic operations .....</b>	<b>18</b>
<b>Listening to radio broadcasts .....</b>	<b>20</b>
Sequential tuning .....	20
Direct tuning .....	21
Preset tuning .....	22
<b>Dolby Pro Logic .....</b>	<b>25</b>
Setting the center mode and adjusting speaker output level .....	25
Adjusting the delay time .....	27
Enjoying SURROUND or 3 STEREO .....	28
<b>SFC (Sound Field Control) .....</b>	<b>29</b>
Adjusting field of sound .....	30
<b>DVD 6CH INPUT mode .....</b>	<b>31</b>
<b>Other functions .....</b>	<b>32</b>
To adjust the tone quality .....	32
To adjust the sound balance .....	32
To mute the sound level .....	32
To listen through headphones .....	32
<b>Making a recording .....</b>	<b>33</b>
Recording on a tape deck .....	33
Recording on a VCR .....	33
<b>Timer function .....</b>	<b>34</b>
Setting the timers .....	34
<b>About the HELP function SA-AX730 only .....</b>	<b>35</b>
<b>Maintenance .....</b>	<b>35</b>
<b>Troubleshooting guide .....</b>	<b>36</b>
<b>Technical specifications .....</b>	<b>37</b>

## Suggestions for safety

### Placement

Avoid placing the unit in areas of:

- direct sunlight
- high temperature
- high humidity
- excessive vibration
- uneven surfaces (Place the unit on a flat level surface.)

Such conditions might damage the cabinet and/or other component parts and thereby shorten the unit's service life.

### Stacking

Never place heavy items on top of the unit or the AC power cord.

### Voltage

- It is very dangerous to use an AC power source of high voltage such as for an air conditioner.  
A fire might be caused by such a connection.
- A DC power source can not be used.  
Be sure to check the power source carefully, especially if on a ship or other place where DC is used.

### Power cord protection

- Avoid cuts, scratches or poor connection of the AC power cord, as this may result in fire or electric shock.  
Excessive bending, pulling or slicing of the cord should also be avoided.
- Do not pull on the cord when you are disconnecting the power, as this could cause an electric shock. Grasp the plug firmly when you disconnect the power supply.
- Never touch the plug with wet hands or a serious electric shock could result.

### Foreign materials

- Ensure that no foreign objects, such as needles, coins, screwdrivers etc., accidentally fall into the unit.  
Otherwise, a serious electric shock or malfunction could occur.
- Be extremely careful about spilling water or liquid on/into the unit, as a fire or electric shock could occur. (Disconnect the power plug and contact your dealer immediately if this occurs.)
- Avoid spraying insecticides onto the unit as they contain flammable gases which can be ignited.
- Insecticides, alcohol, paint thinner and similar chemicals should never be used to clean the unit as they can cause flaking or cloudiness to the cabinet finish.

### Service

- Never attempt to repair, disassemble or reconstruct the unit if there seems to be a problem.  
A serious electric shock could result if you ignore this precautionary measure.
- If a problem occurs during operation (the sound is interrupted, indicators fail to light up, smoke is detected, etc.) contact your dealer or Authorized Service Center immediately.
- Disconnect the power supply if the unit will not be used for a long time. Otherwise the operation life could be shortened.

### CAUTION!

**DO NOT INSTALL OR PLACE THIS UNIT IN A BOOKCASE, BUILT IN CABINET OR IN ANOTHER CONFINED SPACE IN ORDER TO KEEP WELL VENTILATED CONDITION. ENSURE THAT CURTAINS AND ANY OTHER MATERIALS DO NOT OBSTRUCT THE VENTILATION CONDITION TO PREVENT RISK OF ELECTRIC SHOCK OR FIRE HAZARD DUE TO OVERHEATING.**

### CAUTION

Do not place a tape deck, CD, or DVD player on top of this unit. Heat radiated from the top of this unit may cause damage to the software.

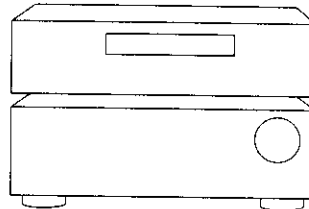

**NO**

## Surround guide

You are able to enjoy these two surround systems with this receiver.

### Surround system

#### Dolby Pro Logic

### Features

Dolby Pro Logic is a decoding system that was developed to get a better sense of presence from sources encoded with Dolby Surround. The feeling of position has been improved by the addition of a separate center speaker channel. Dolby Surround was developed to allow enjoyment of Dolby Stereo, a cinema system, in private homes. This system reproduces sound close to that of the original movie through use of an analog matrix.

This unit has two types of Dolby Pro Logic.

- **SURROUND:** the surround speakers are used.
  - **3 STEREO:** the surround speakers are not used.
- (⇒Page 25.)

### Software

- Video tapes
- Laser discs
- DVDs
- CDs

Software encoded with Dolby Surround can be identified with this mark.



#### SFC (Sound Field Control)

SFC allows you to add surround-like effects to sources not formatted with Dolby Surround, Dolby Digital, or DTS.

Various effects, like a concert hall or jazz club, can be achieved by introducing width or reverberation to the original sound.

(⇒Page 29.)

Any kind, but particularly music CDs and video tapes.

### Other surround systems

The following systems require special decoders. To enjoy them connect unit with the decoders. The playback equipment itself may contain the decoder or you may need to obtain a digital surround processor, such as a Technics SH-AC300.

#### Dolby Digital (AC-3)

Dolby Digital is a discrete 6 (5.1) channel digital surround system developed for cinema use.

The sound signals in Dolby Digital format are compressed to 1/12 their original size, allowing an entire movie to be recorded on a single DVD.

Not all Dolby Digital sources are recorded with 6 channels. Some sources marked Dolby Digital may be recorded in Dolby Surround, a 2 channel system.

(⇒Page 31.)

- DVDs

Software encoded with Dolby Digital can be identified with this mark.



## Concerning the remote control

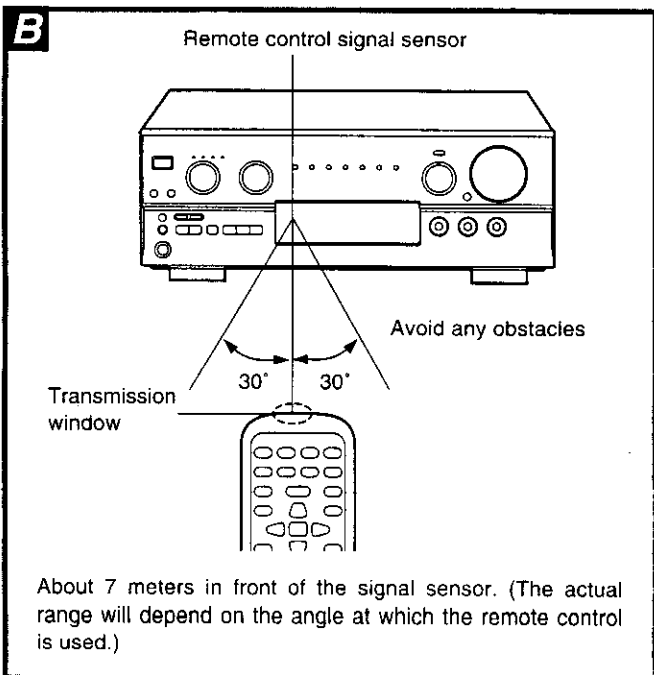
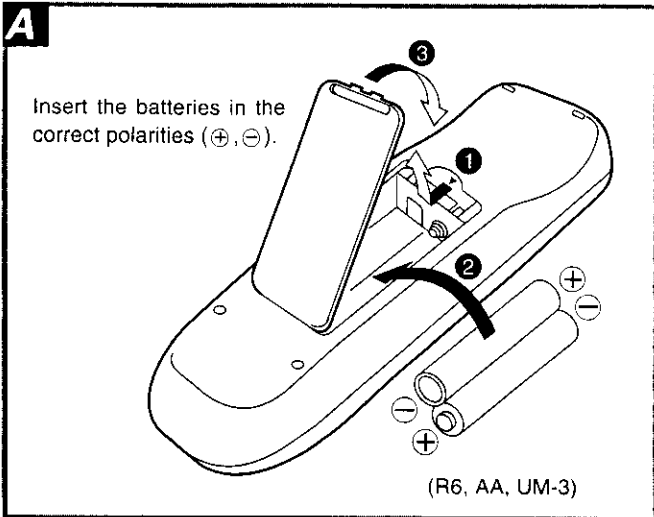

### Battery installation **A**

#### Use of batteries

- Do not mix old and new batteries, or batteries of different types (manganese and alkaline, etc.).
- Never subject batteries to excessive heat or flame; do not attempt to disassemble them; and be sure they are not short-circuited.
- If the remote control is not to be used for a long period of time, remove the batteries and store them in a cool, dark place.
- Do not attempt to recharge alkaline or carbon batteries.
- Do not use rechargeable type batteries.

### Correct method of use **B**

#### Operation notes

- Do not place obstacles between the remote control signal sensor and remote control unit.
- Do not expose the remote control signal sensor to direct sunlight or to the bright light of an inverter fluorescent light.
- Take care to keep the remote control signal sensor and end of the remote control unit free from dust.
- If the unit is installed in a rack with glass doors, the glass doors' thickness or color might make it necessary to use the remote control a shorter distance from the unit.

#### To prevent damage

- Never place heavy items on top of the unit.
- Do not disassemble or reconstruct the unit.
- Do not spill water or other liquids into the unit.

Before use

## Front panel controls

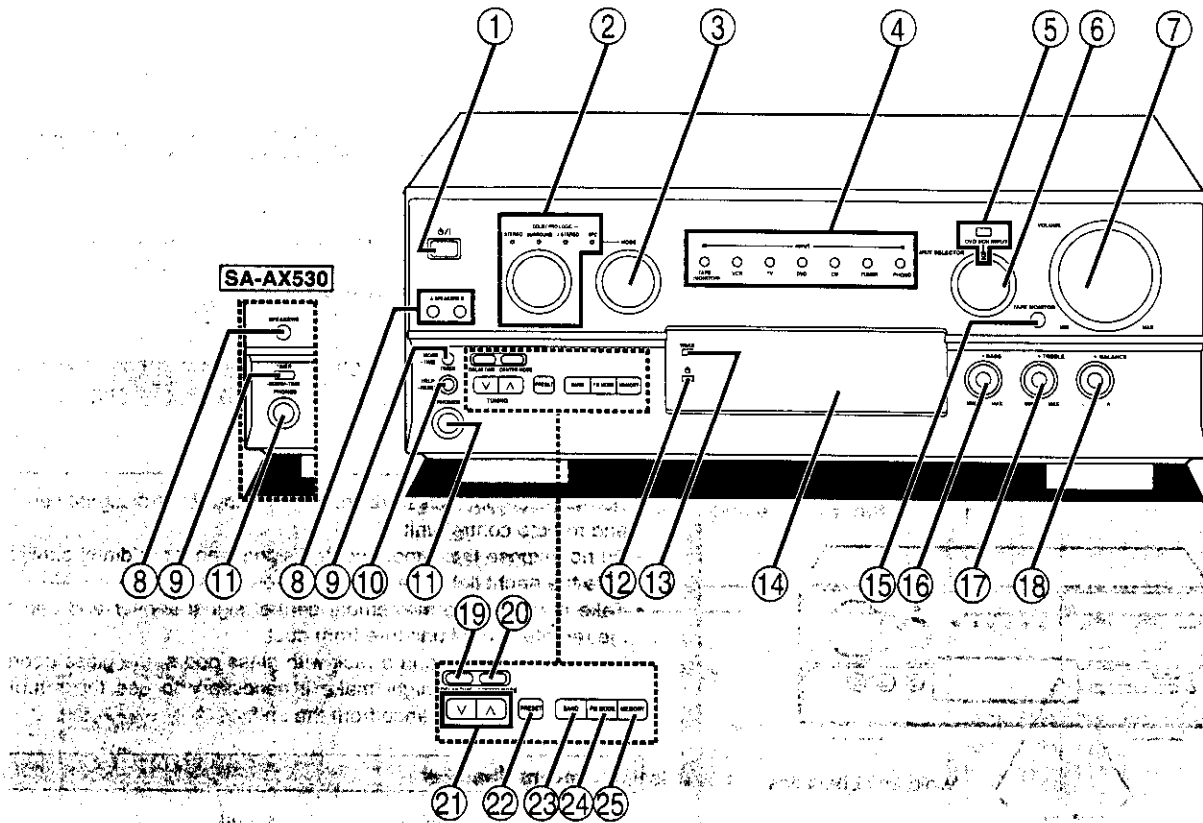

### Main unit

No.	Name	Ref. page	No.	Name	Ref. page
①	Standby / on switch (⏻/⏻) .....	18	⑫	Standby indicator (⏻)	
	Press to switch the unit from on to standby mode or vice versa. In standby mode, the unit is still consuming a small amount of power.			When the unit is connected to the AC mains supply, this indicator lights up in standby mode and goes out when the unit is turned on.	
②	Dolby Pro Logic mode selector/indicators .....	25	⑬	Wake indicator (WAKE) .....	34
③	SFC mode selector (MODE) .....	29	⑭	Display	
④	Input indicators .....	18	⑮	Tape monitor button (TAPE MONITOR) .....	19
⑤	DVD 6ch input select button/indicator (DVD 6CH INPUT) .....	31	⑯	Bass control (BASS) .....	32
⑥	Input selector (INPUT SELECTOR) .....	18	⑰	Treble control (TREBLE) .....	32
⑦	Volume control (VOLUME) .....	18	⑱	Balance control (BALANCE) .....	32
⑧	<b>SA-AX730</b> Speaker select buttons (A SPEAKERS B) .....	18	⑲	Delay time adjust button (DELAY TIME) .....	27
	<b>SA-AX530</b> Speaker button (SPEAKERS) .....	18	⑳	Center mode select button (CENTER MODE) .....	25
⑨	Timer button (TIMER, -MODE, -TIME) .....	34	㉑	Tuning buttons (TUNING ∇, ▲) .....	20
⑩	<b>SA-AX730 only</b> Help/reset button (-HELP, -RESET) .....	35	㉒	Preset channel button (PRESET) .....	24
⑪	Headphones jack (PHONES) .....	32	㉓	Band select button (BAND) .....	20
			㉔	FM mode select button (FM MODE) .....	20
			㉕	Memory button (MEMORY) .....	22

## Front panel controls

### Remote control

The pages referred to on this page are in the booklet "How to use the remote control transmitter." The page numbers in boxes **26** refer to pages in this manual.

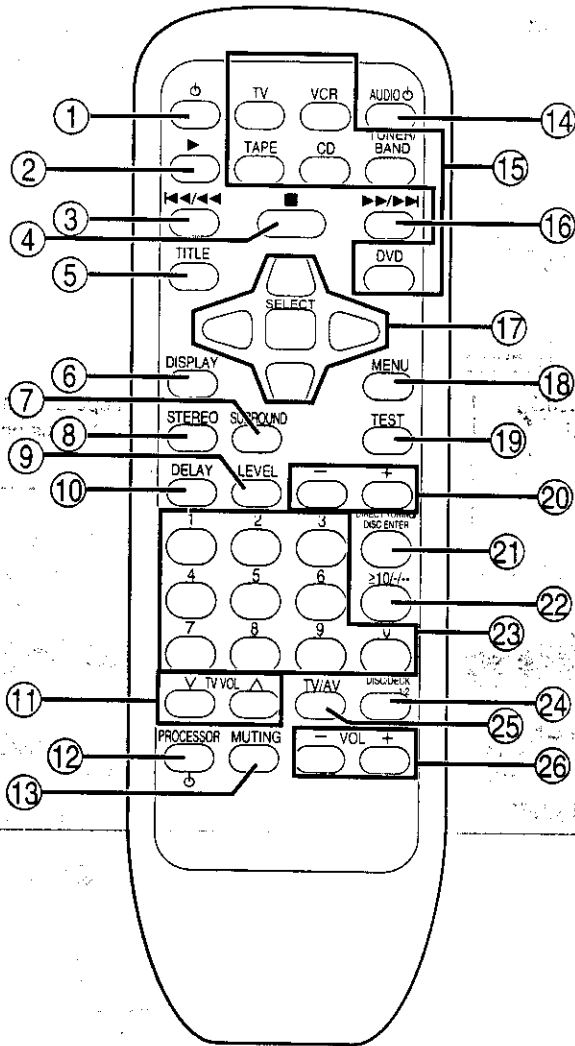

No.	Name	Ref. page
①	Standby / on button (⏻) .....	2
②	▶ button (▶) .....	5
③	◀◀/◀ button (◀◀/◀) .....	5
④	■ button (■) .....	5
⑤	Title button (TITLE) .....	Back cover
⑥	Display button (DISPLAY) .....	Back cover
⑦	Dolby Pro Logic surround select button (SURROUND) .....	3
⑧	Dolby Pro Logic off button (STEREO) .....	3
⑨	Speaker channel select button (LEVEL) .....	3, <b>26</b>
⑩	Delay time button (DELAY) .....	3
⑪	TV volume buttons (∇ TV VOL ▲) .....	7
⑫	Processor on/off button (PROCESSOR ⏻) .....	6
⑬	Muting button (MUTING) .....	2, <b>32</b>
⑭	Audio off button (AUDIO ⏻) .....	2
⑮	Input select buttons (TV, VCR, TAPE, CD, TUNER/BAND, DVD) .....	2
⑯	▶▶/▶ button (▶▶/▶) .....	5
⑰	Cursor/select buttons .....	Back cover
⑱	Menu button (MENU) .....	Back cover
⑲	Test button (TEST) .....	3, <b>26</b>
⑳	Delay time/level adjust buttons (-, +) .....	3, <b>26</b>
㉑	Direct tuning/disc enter button (DIRECT TUNING/DISC ENTER) .....	5, <b>21</b>
㉒	≥10/-/- button (≥10/-/-) .....	5
㉓	Numeric buttons .....	5, <b>21</b>
㉔	Disc/deck 1/2 select button (DISC/DECK 1/2) ....	5
㉕	TV/AV select button (TV/AV) .....	7
㉖	Volume buttons (-VOL+) .....	2, <b>26</b>

Before use

# Equipment connections (SA-AX730)

Stereo connection cable (not included)

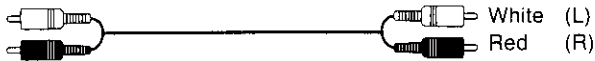

Video connection cable (not included)

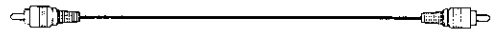

Make sure that the power supply for all components has been turned off before making any connections.

To connect equipment, refer to the appropriate operating instructions.

**Note**

Do not place books, etc., on the top of this unit or block the heat radiation vents in any way.

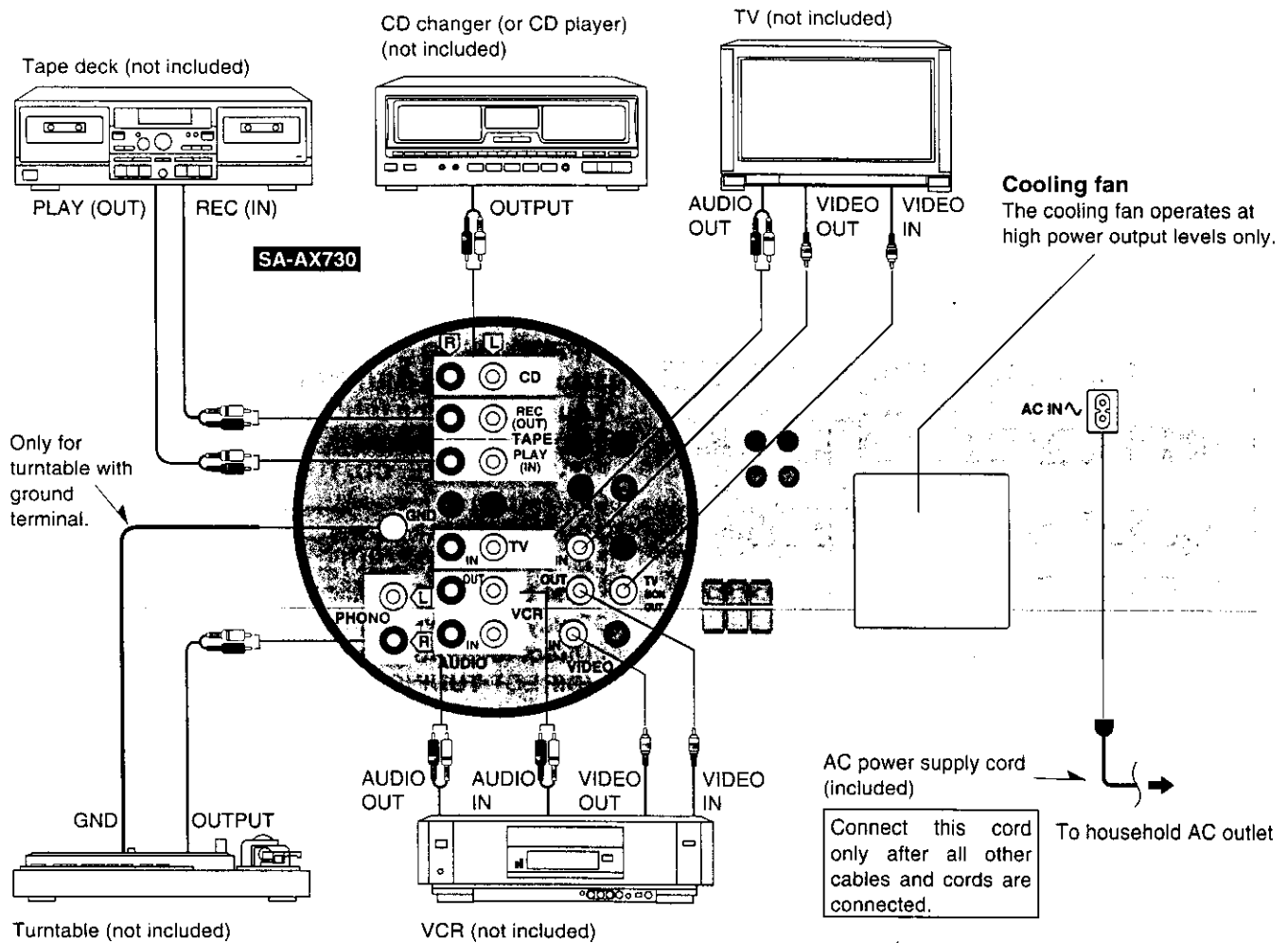

**AC power supply cord**

Voltage selector

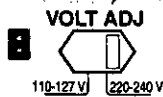

(For areas except Australia and N.Z.)

Set the voltage selector to the voltage setting for the area in which the unit will be used.

**Note**

This unit will be seriously damaged if this setting is not made correctly.

(For areas except Australia and N.Z.)

**Insertion of Connector**

Even when the connector is perfectly inserted, depending on the type of inlet used, the front part of the connector may jut out as shown in the drawing.

However there is no problem using the unit.

Appliance inlet

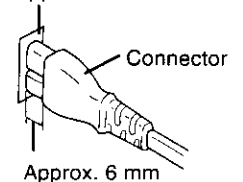

If the power plug will not fit your socket, use the power plug adaptor (included).

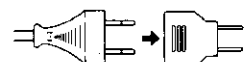



Monaural connection cable (not included)



Optical fiber cable (not included)



## Connecting a DVD player

6 channel discrete connection enables you to enjoy the sound field effects recorded on DVDs.

SA-AX730

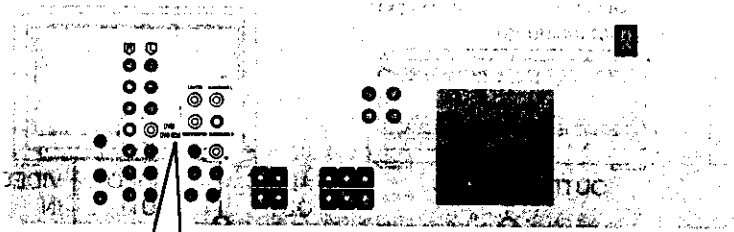

• If your DVD player has surround decoders

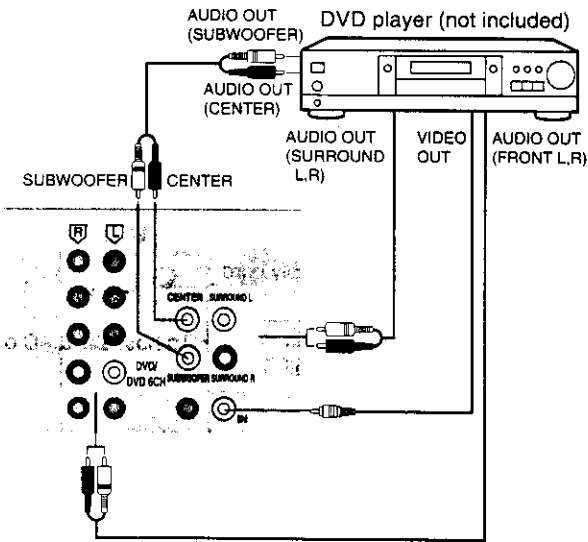

• If your DVD player doesn't have surround decoders  
Obtain a separately available digital surround processor.

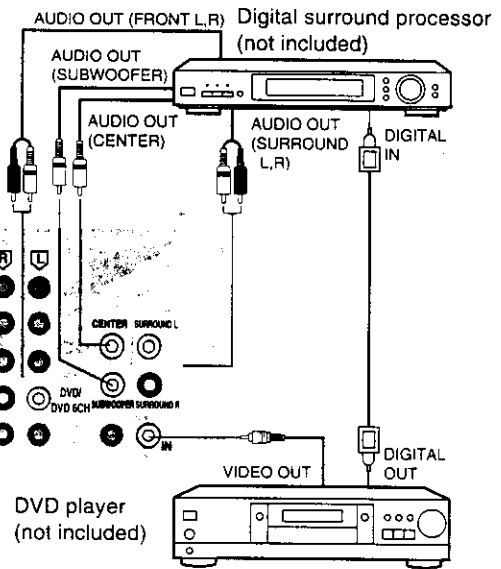

• Stereo connection

Use this connection if none of your equipment has a surround decoder.

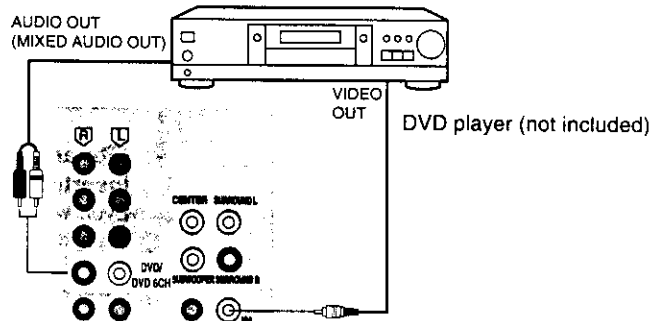

# Equipment connections (SA-AX530)

## Stereo connection cable (not included)



## Video connection cable (not included)

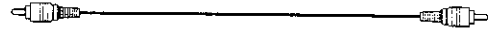

Make sure that the power supply for all components has been turned off before making any connections.

To connect equipment, refer to the appropriate operating instructions.

### Note

Do not place books, etc., on the top of this unit or block the heat radiation vents in any way.

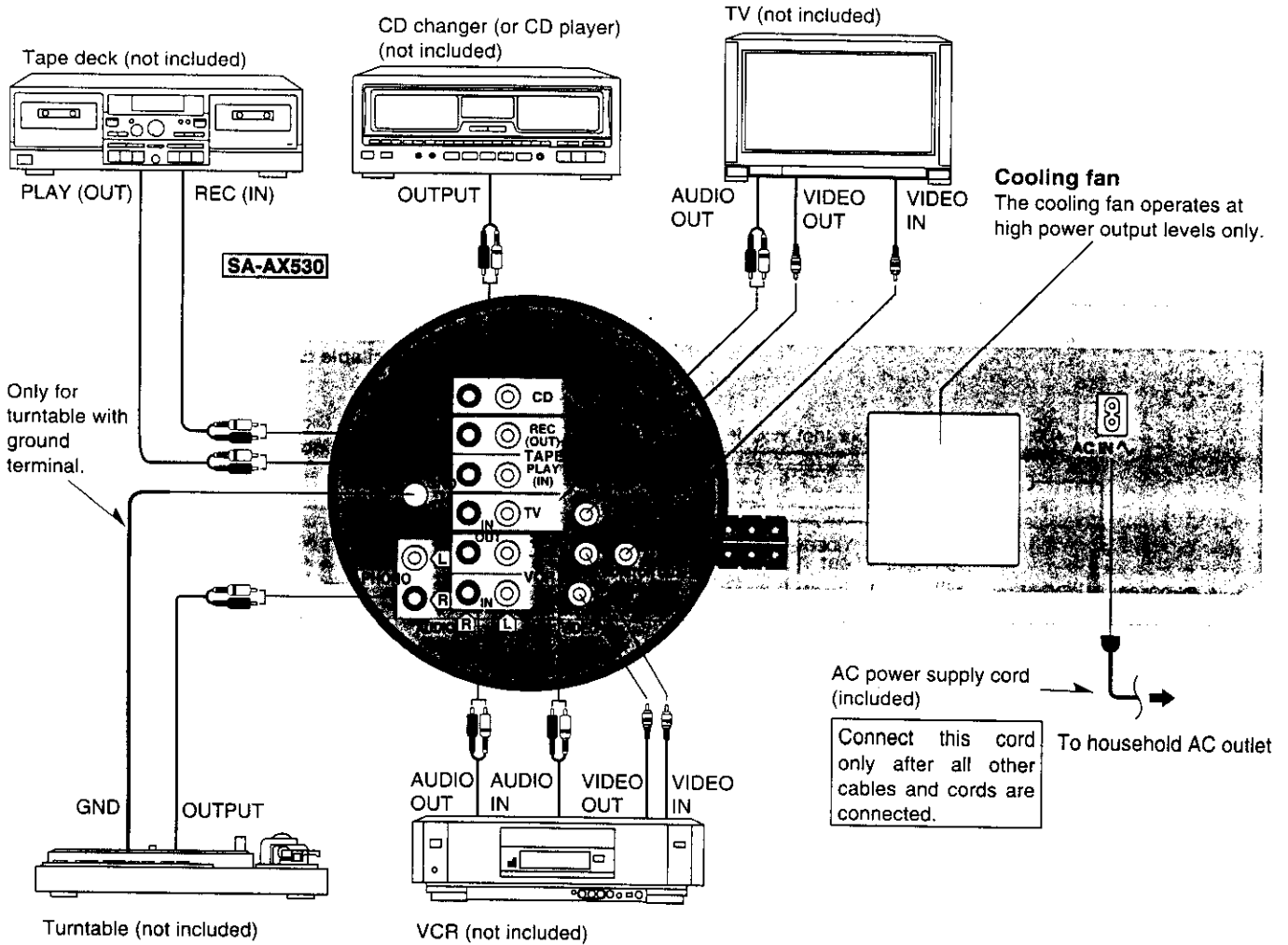

## AC power supply cord

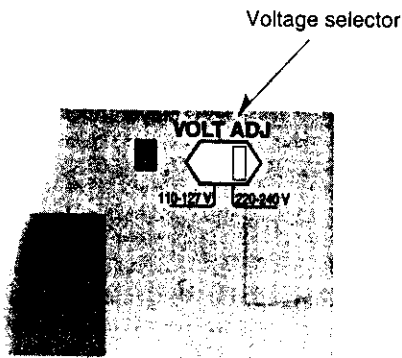

### (For areas except Australia and N.Z.)

Set the voltage selector to the voltage setting for the area in which the unit will be used.

### Note

This unit will be seriously damaged if this setting is not made correctly.

### (For areas except Australia and N.Z.)

#### Insertion of Connector

Even when the connector is perfectly inserted, depending on the type of inlet used, the front part of the connector may jut out as shown in the drawing.

However there is no problem using the unit.

#### Appliance inlet

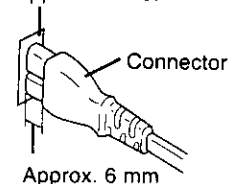

If the power plug will not fit your socket, use the power plug adaptor (included).

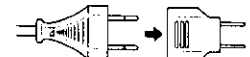

Monaural connection cable (not included)



Optical fiber cable (not included)

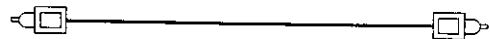

## Connecting a DVD player

6 channel discrete connection enables you to enjoy the sound field effects recorded on DVDs.

SA-AX530

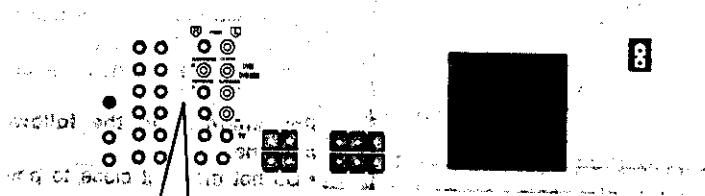

• If your DVD player has surround decoders

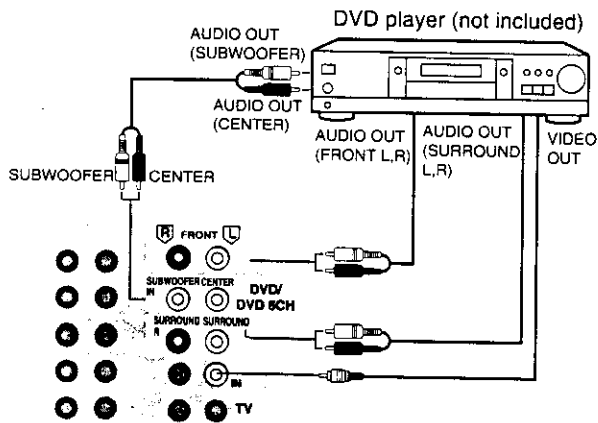

• If your DVD player doesn't have surround decoders  
Obtain a separately available digital surround processor.

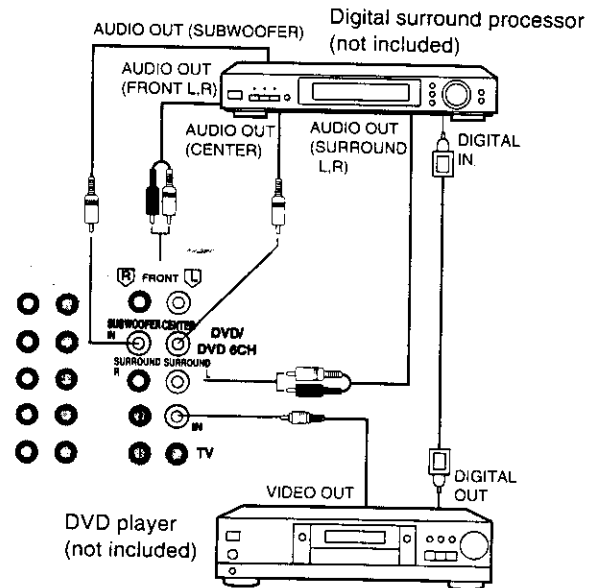

• Stereo connection

Use this connection if none of your equipment has a surround decoder.

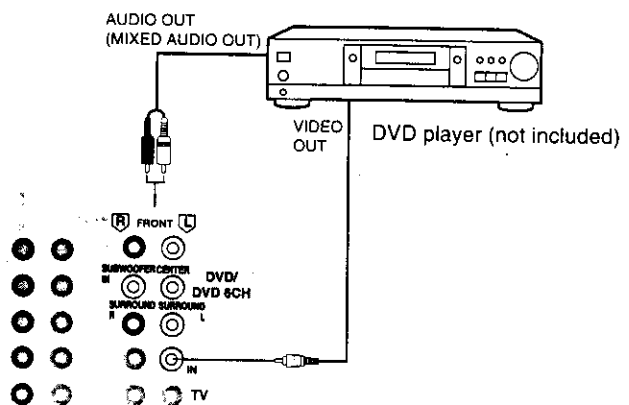

## Antenna connections

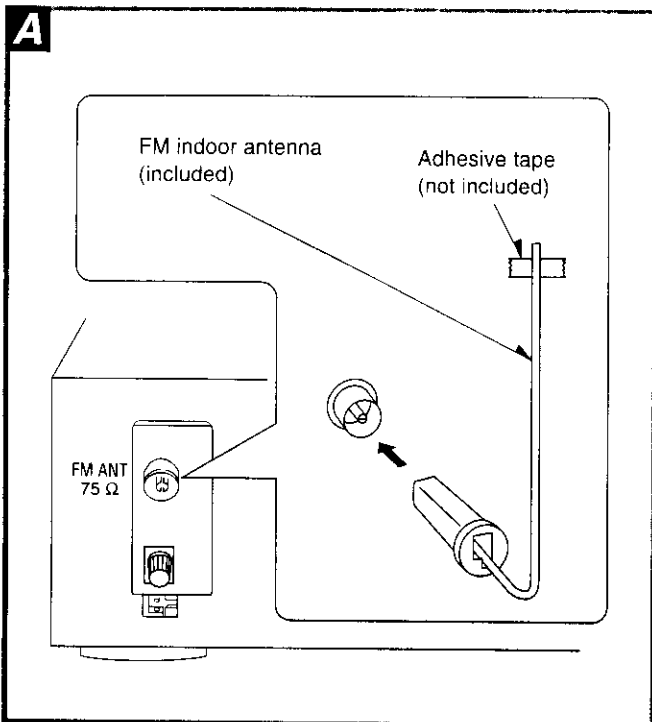

### FM indoor antenna (included) **A**

This antenna is normally sufficient for reception of FM broadcasts.

Attach to a wall (using tape) facing in the direction of best reception.

#### For best reception

An FM outdoor antenna is recommended.

### AM loop antenna (included) **B**

This antenna is normally sufficient for reception of AM broadcasts.

Fit the AM loop antenna holder (included) onto the rear panel of this unit and then attach the AM loop antenna to the AM loop antenna holder (facing in the direction of best reception).

#### Pay attention to the following points when mounting the antenna.

- Do not mount it close to power cords, speaker wires or metal surfaces (doing so will result in noise).
- Do not mount it close to a tape deck. When the tape deck is being used, chirping or beeping sounds may result.

### When mounting the antenna to a column, a wall or rack **C**

Mount the antenna so that the hinge is vertical.

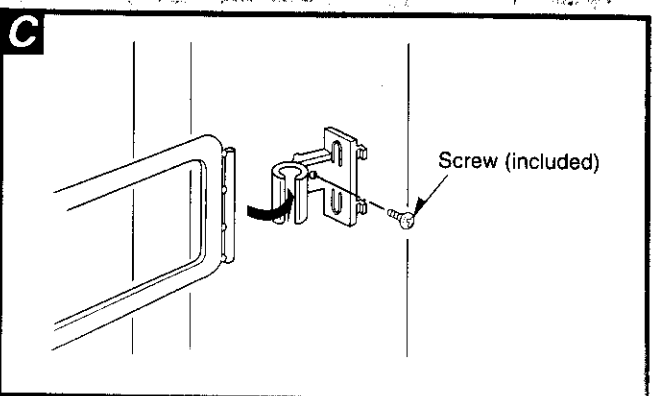
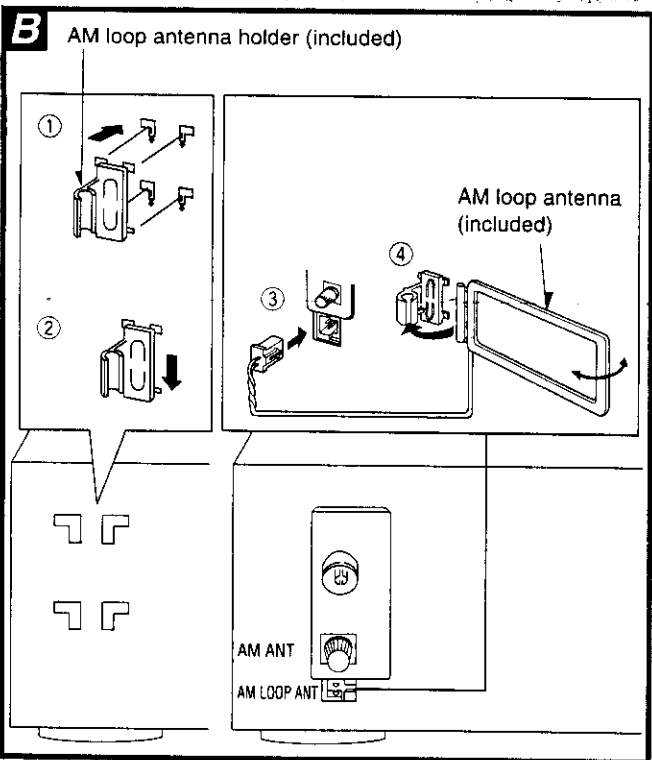

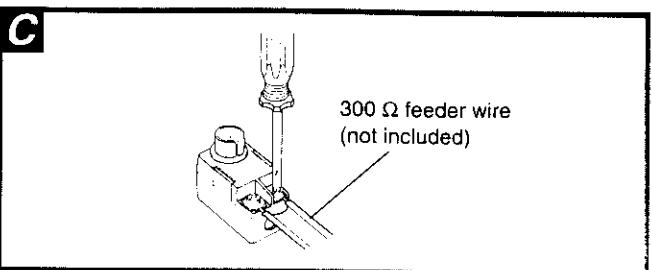
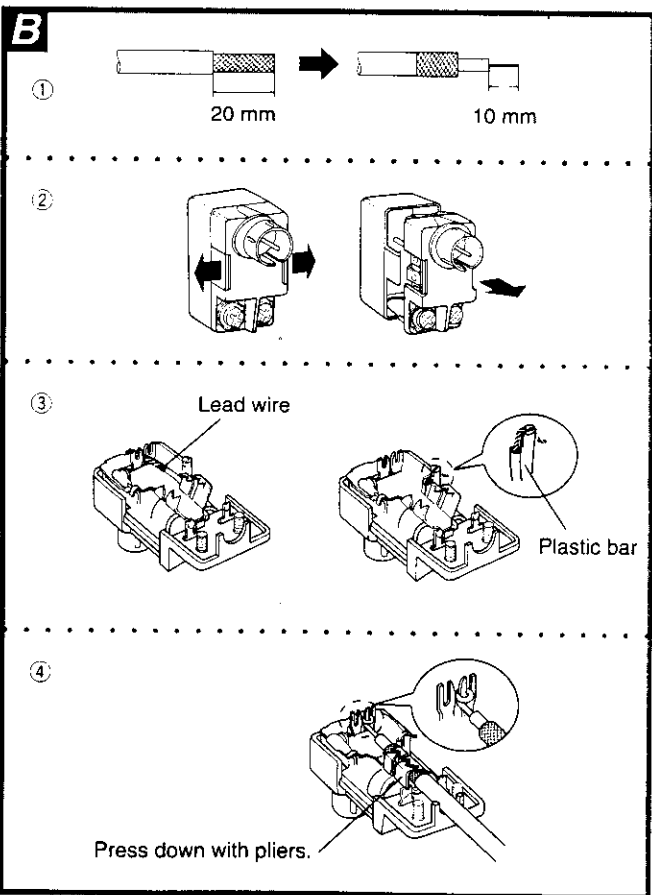
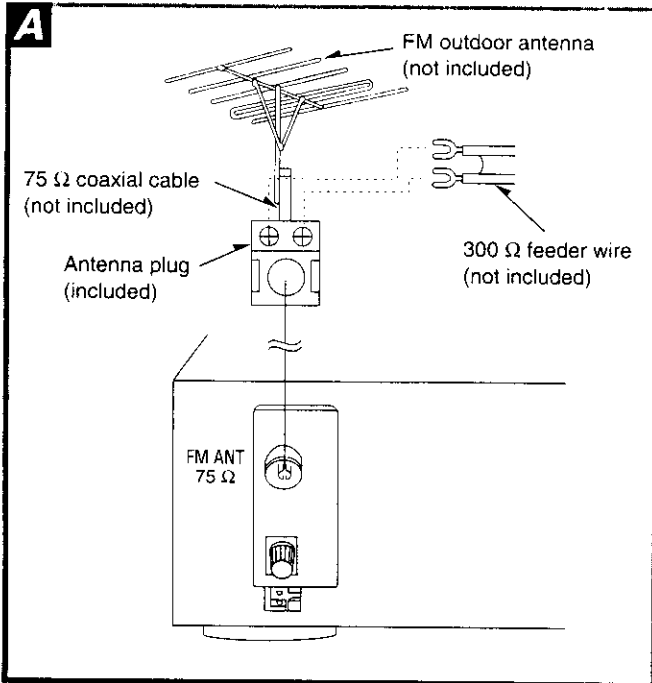

**FM outdoor antenna (not included) A**

An outdoor antenna should be used when using this unit in mountainous areas or in spaces enclosed by reinforced concrete where the FM indoor antenna (included) does not provide satisfactory reception.

Disconnect the FM indoor antenna if an FM outdoor antenna is installed.

**Note**

An outdoor antenna should be installed by a qualified technician only.

**How to use the antenna plug (included)**

Two types of wire are most commonly used for connection from the antenna: 300 Ω parallel feeder wire or 75 Ω coaxial cable. For best resistance to outside interference, the use of 75 Ω coaxial cable is suggested.

**To connect a 75 Ω coaxial cable B**

- ① Remove a piece of the outer vinyl insulator.
- ② Remove the cover while pulling the tabs.

**Note**

If the tabs are pulled too hard, the casing may be damaged.

- ③ Remove the lead wire and clamp it with the plastic bar.
- ④ Install the coaxial cable.  
Clamp the cable conductor, and wind it on so that it doesn't contact anything else.
- ⑤ Attach the cover.

**To connect a 300 Ω feeder wire C**

Loosen the screw to connect the feeder wire and tighten it to secure the connection.

## Antenna connections

### AM outdoor antenna (not included)

An outdoor antenna should be used when using this unit in mountainous areas or in spaces enclosed by reinforced concrete where the AM loop antenna (included) does not provide satisfactory reception.

Stretch 5–12 m of vinyl-covered wire horizontally across a window frame or other convenient location, keeping it as high as possible from the ground.

When the unit is not in use, disconnect the outdoor antenna to prevent possible damage that may be caused by lightning. Never use an outdoor antenna during an electrical storm.

#### Note

Be sure to connect the AM loop antenna even when an outdoor antenna is used.

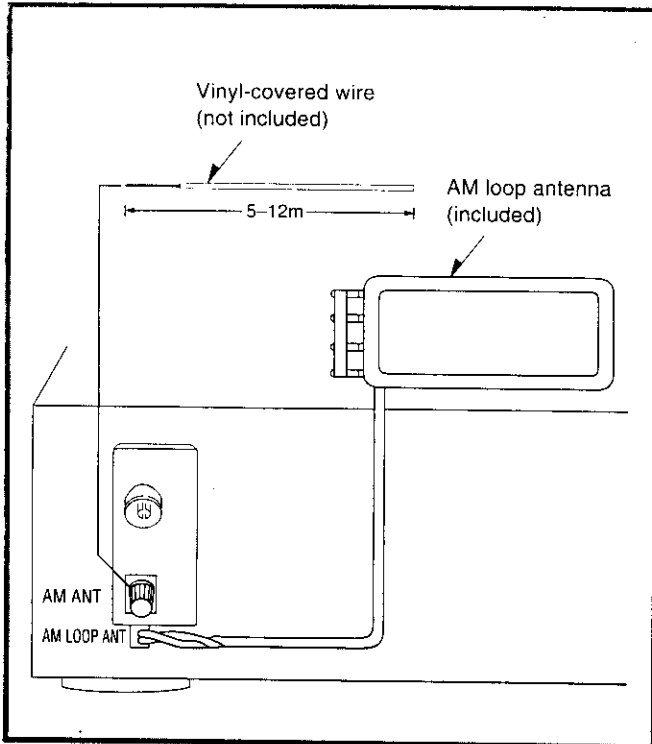

# Speaker connections

## Placement of speakers

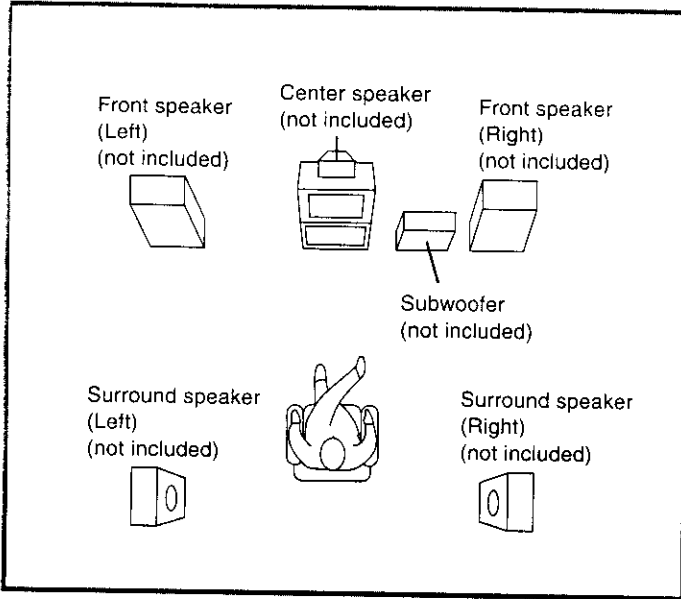

### Front speakers

Place the front speakers on the left and right of the TV at seated ear height so there is good coherency between the picture and sound.

### Center speaker

Place this speaker underneath or above the center of the TV. Aim the speaker at the seating area.

### Surround speakers

Place these speakers on the side of or slightly behind the listener, and about one meter higher than ear level.

### Subwoofer

The subwoofer can be placed in any position as long as it is at a reasonable distance from the TV.

Note that some experimentation can yield the smoothest low frequency performance. Placement near a corner can increase the apparent output level, but can result in unnatural bass.

## Connecting the cables

(For only front "A" terminals of SA-AX730)

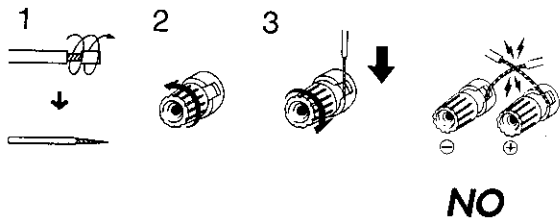

(For other speaker terminals)

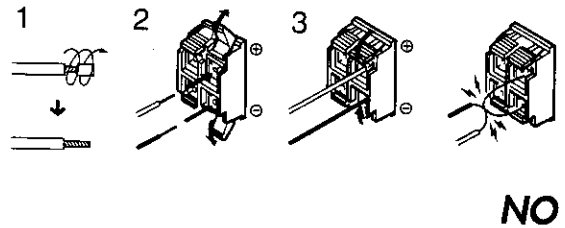

Connections

**Connecting speakers**

Other connections are possible depending on your speaker system. See your speaker system's operating instructions for details.

**Front speakers**

**SA-AX730**

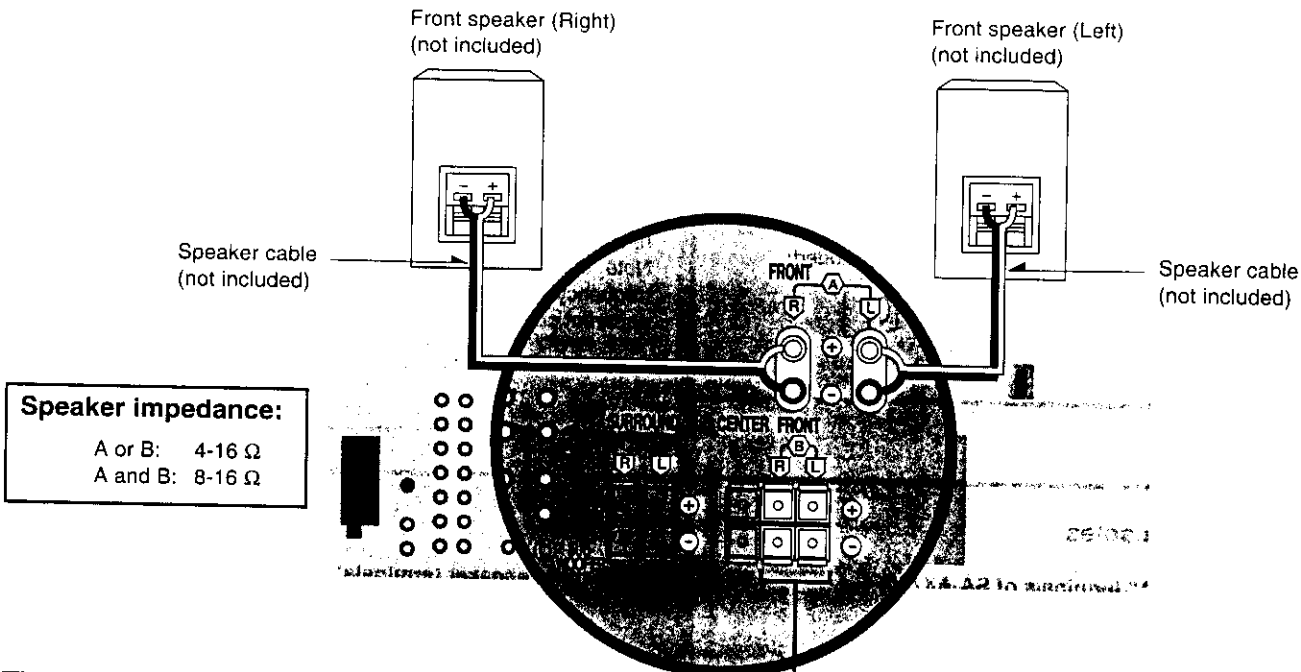

**Note**

Use the A terminals to enjoy Dolby Pro Logic and DVD 6CH INPUT.

**"B" terminals**  
 For connection to a second pair of speakers.

**SA-AX530**

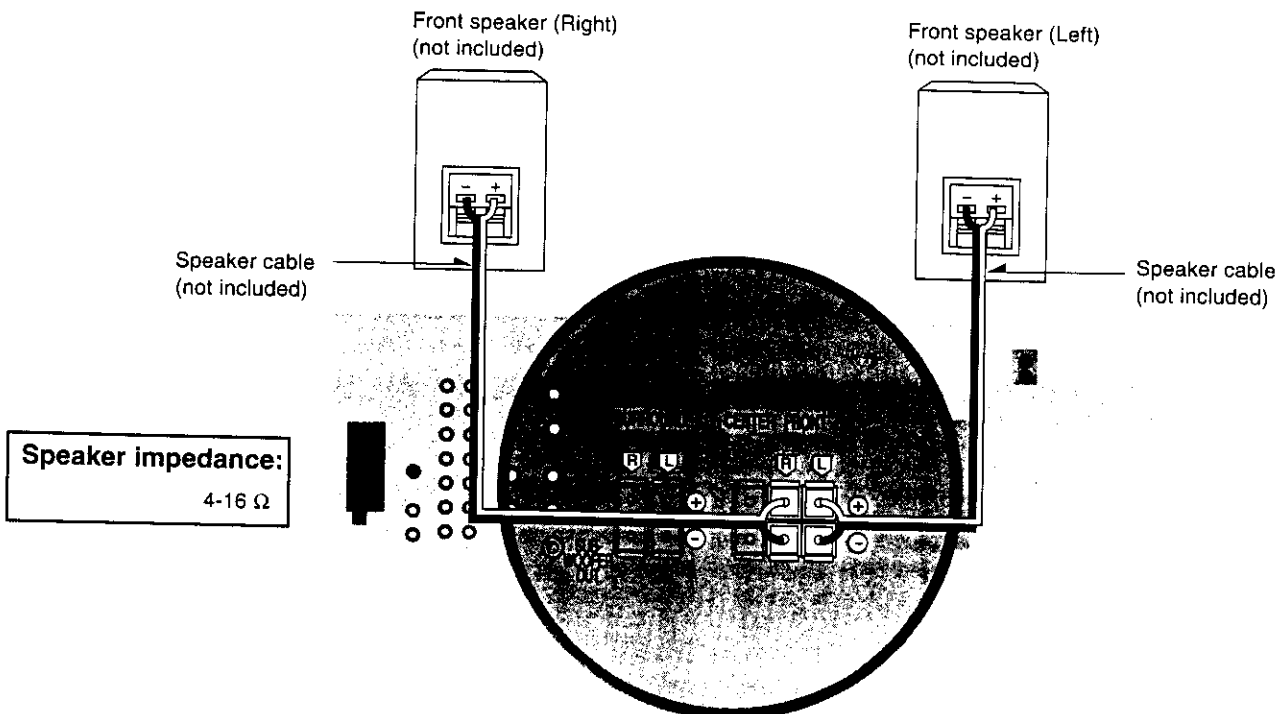



## Other speakers

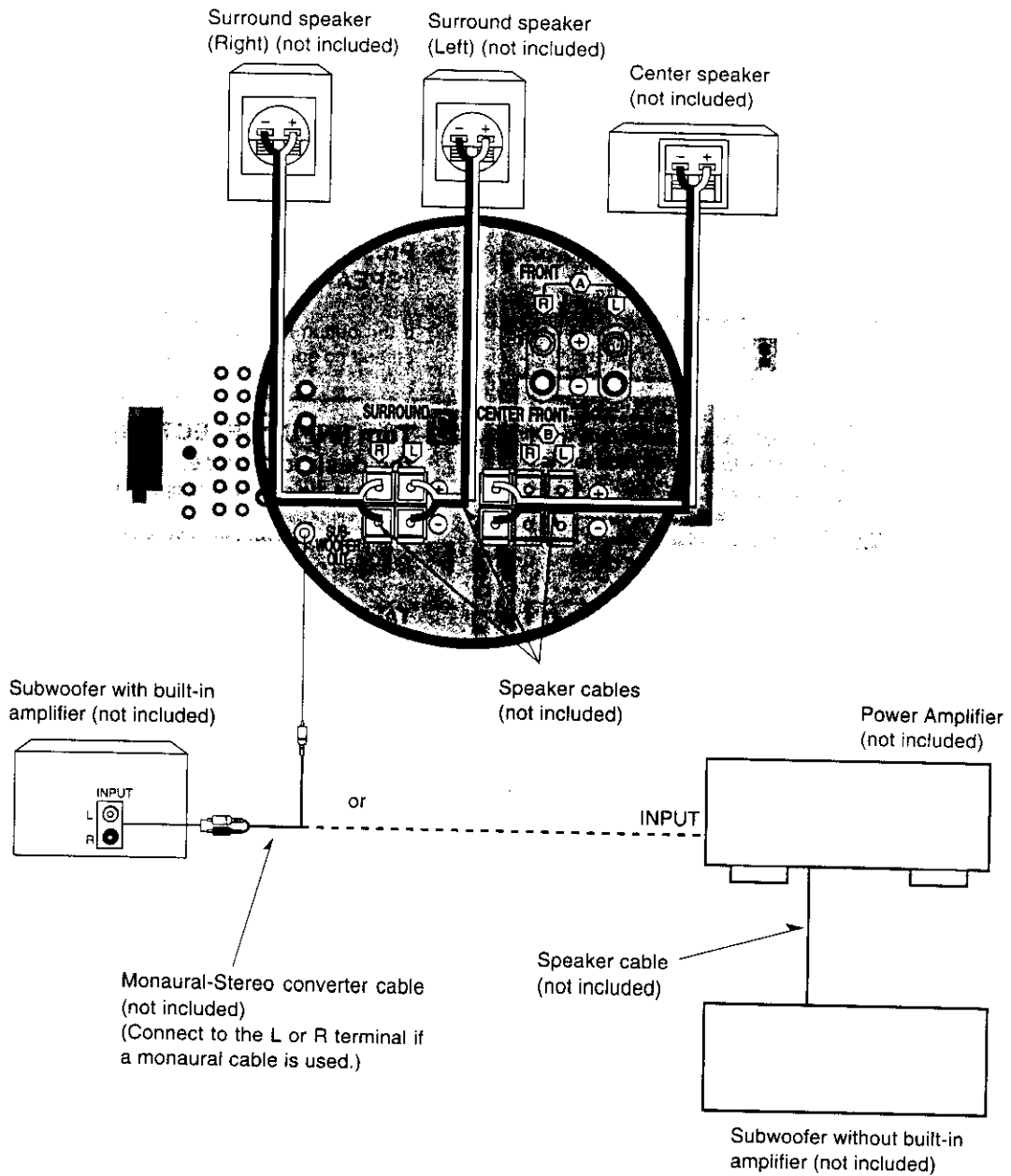

### For surround speakers

#### Note

Do not connect the surround speakers to the front speaker terminals. The surround speakers may be damaged if connected to the front terminals.

#### Speaker impedance:

Center speaker:	6-16 $\Omega$
Surround speaker:	6-16 $\Omega$

### For subwoofer

#### Note

This receiver has no amplifier section designed especially for the subwoofer.

#### For your reference

Connection to a passive subwoofer with front speaker terminals is also possible. (See the operating instructions of the speaker system for details.)

Connections

## Basic operations

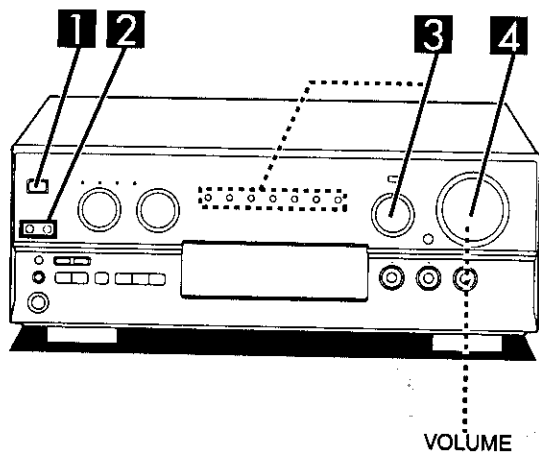

Before operation, set [VOLUME] to the "MIN" position.

**1** Press [ $\phi$ /I].

**2** SA-AX730

Press [A] and/or [B] to select the speaker system(s) to be used.

A and B refer to the speaker terminals at the rear of the unit.

SA-AX530

Press [SPEAKERS] and check the "SPEAKERS" indication lights up.

If the button is pressed once more, the indicator will switch off and no sound will be heard from the speakers.

**3** Turn [INPUT SELECTOR] to select and start the desired source.

(Refer to the appropriate operating instructions for details.)

The indicator corresponding to the selected source lights and is shown on the display.

**TAPE (MONITOR):** To listen to cassette tapes

**VCR:** To watch video tapes

**TV:** To watch TV

**DVD:** To watch DVD

**CD:** To listen to compact discs

**TUNER:** To listen to radio broadcasts

**PHONO:** To listen to phono discs

### Note

To watch a video (or DVD) or the TV, set the TV to either the TV mode or VIDEO mode.

**4** Adjust the volume.

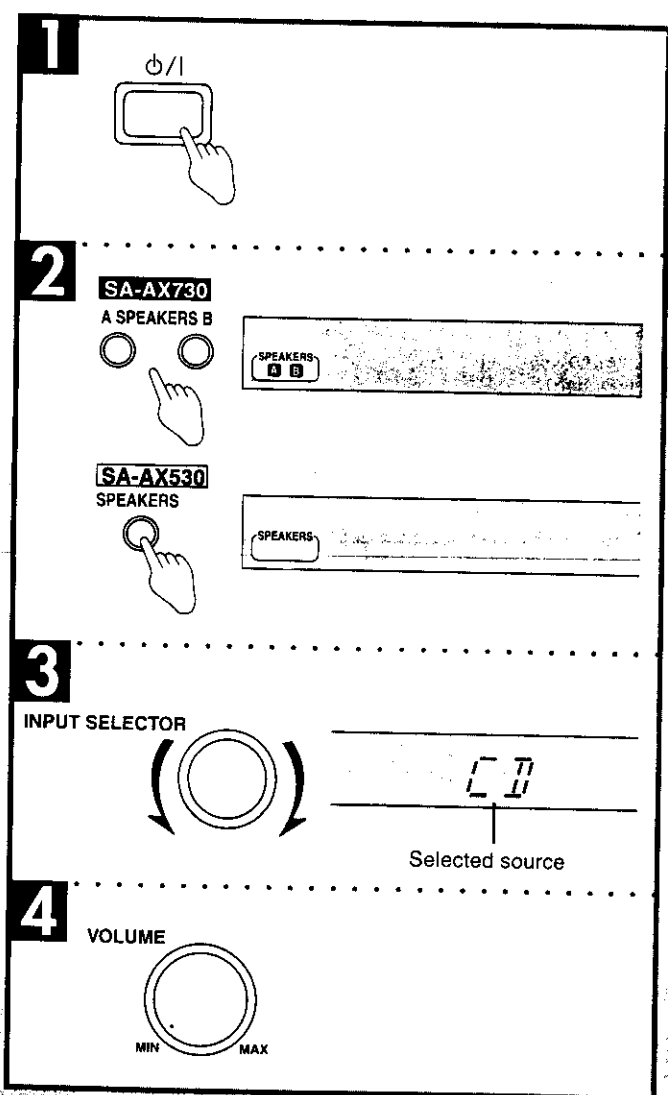

### For your reference

- If a Dolby Pro Logic or SFC mode has been selected  
After displaying the selected source, the display will then change to show the Dolby Pro Logic or SFC mode.  
(→ page 28, 29)  
If the source chosen was TUNER then the display will change again to show the frequency.

- If you are using VCR and you select TAPE, CD, TUNER, or PHONO  
The picture will remain on the screen.

### When you finish listening

Be sure to reduce the volume level, and switch the power to the standby condition by pressing [ $\phi$ /I].

## Basic operations

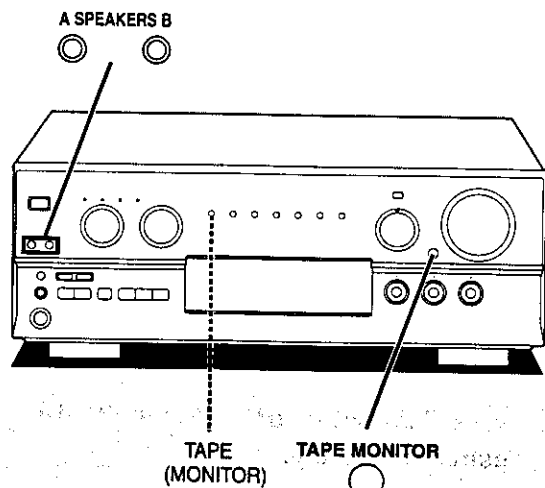

For front speakers with an impedance under  $6 \Omega$  **A**

Do the following to set output to "LOW IMP" if any of your front speakers has an impedance under  $6 \Omega$ .

### SA-AX730

Press and hold [A] or [B] until "LOW IMP" lights up on the display.

### SA-AX530

Press and hold [SPEAKERS] until "LOW IMP" lights up on the display.

(Press and hold down once again for 4 seconds or more to turn it off.)

### SA-AX730 only

Note that when "LOW IMP" is illuminated, speakers [A] and [B] cannot both be used at the same time.

### To change speakers:

e.g. To use speaker B, press [A] ("A" goes out), and then press [B] to activate speaker B.

### The TAPE (MONITOR) indicator

This indicator lights in the following two situations.

1. While TAPE is selected.
2. While TAPE MONITOR is in use.

### Tape monitor **B**

If [TAPE MONITOR] is pressed while a source other than TAPE is selected, the "TAPE (MONITOR)" indicator lights and the tape monitor comes on.

Sources other than tape can still be selected with [INPUT SELECTOR] while the "TAPE (MONITOR)" indicator is on.

Press [TAPE MONITOR] again to turn the tape monitor off.

(→ See "Making a recording" on page 33 for details on how to use the tape monitor during recording.)

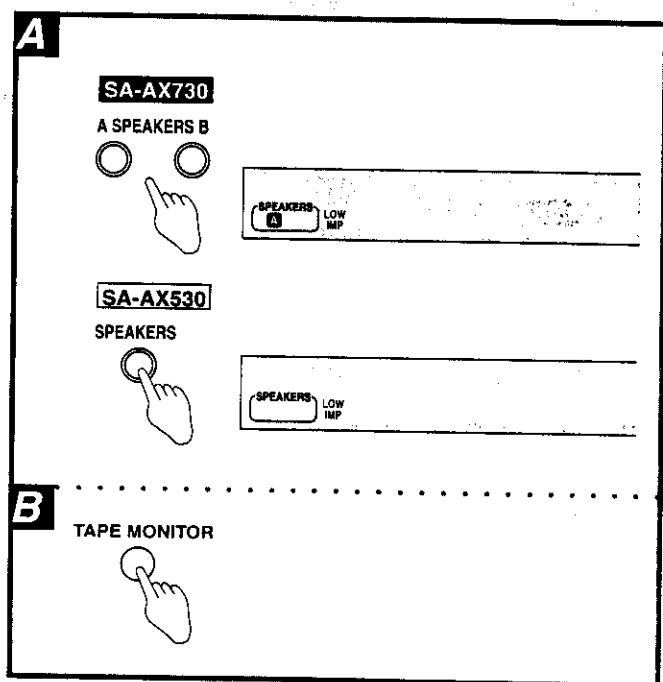

## Listening to radio broadcasts

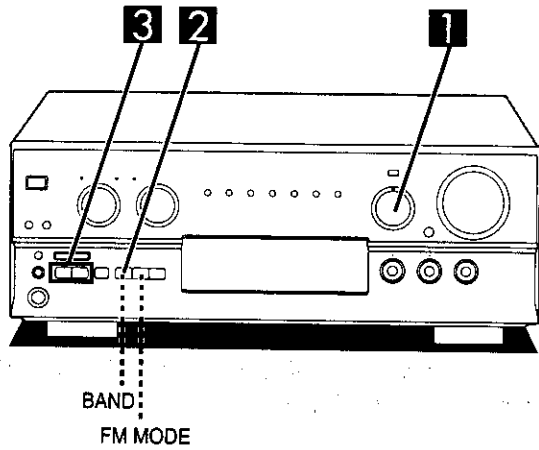

### Sequential tuning

Use the tuning buttons to tune-in radio stations.

- 1 Turn [INPUT SELECTOR] to select "TUNER".
- 2 Press [BAND] to select "FM" or "AM".
- 3 Press [TUNING (∨ or ∧)] to tune to the desired frequency.

"QUARTZ LOCK" lights up when tuned.

"STEREO" lights up when an FM stereo broadcast is received.

#### To make an automatic search for stations

If [TUNING (∨ or ∧)] is held down for an instant until the frequency begins to scroll, the broadcast stations are tuned in automatically when one is found.

#### Note

Tuning may stop automatically if any jamming is encountered.

#### If noise is excessive in the FM stereo mode

Press [FM MODE].

("STEREO" will go out, and "MONO" will light up)

The broadcast will be monaural, but noise will be reduced.

If the button is pressed once more, the stereo mode resumes.

#### For your reference

The tuner can pick up interference from DVD players. If this occurs turn the DVD off.

#### To change the AM frequency step

Press and hold [BAND] for about 3 seconds when AM band is selected. (The frequency step changes from 9 kHz to 10 kHz per step.)

To return to the previous step, press and hold [BAND] for about 3 seconds again.

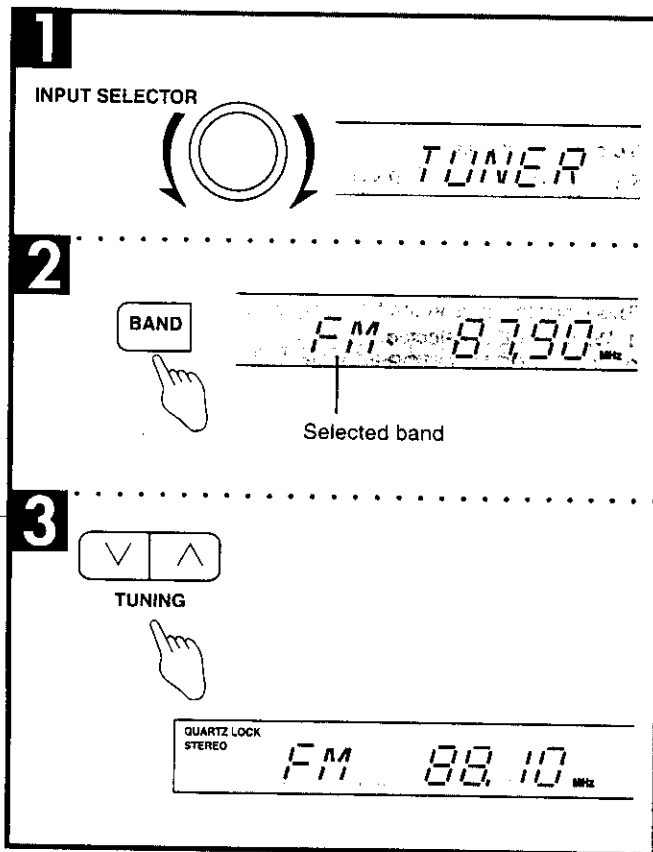

## Listening to radio broadcasts

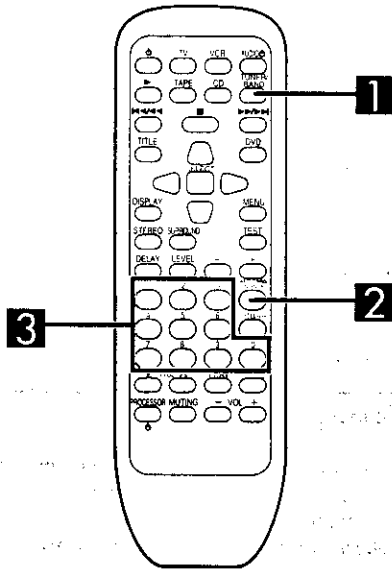

### Direct tuning

#### by remote control only

Specify the frequency using the numeric buttons on the remote control to directly tune to the desired station.

#### 1 Press [TUNER/BAND].

This will set the remote control to operate the tuner. The selector on the receiver will change to "TUNER". Each time the button is pressed, the band will change as follows,  
FM ↔ AM.

#### 2 Press [DIRECT TUNING/DISC ENTER].

#### 3 While cursor display is flashing (approx. 10 seconds) Press the numeric buttons to enter the frequency.

If the desired FM frequency is 107.90 MHz, press  
[1] → [0] → [7] → [9] → [0].

If the frequency has been input correctly, the displayed frequency will blink once.

#### Note

1. If no button is pressed while the cursor display is flashing, the display will return to the frequency which is currently being received. To re-specify the frequency, repeat the procedure from step 2.
2. If the frequency has not been input correctly, "ERROR" will be displayed. In this case, re-enter the frequency.

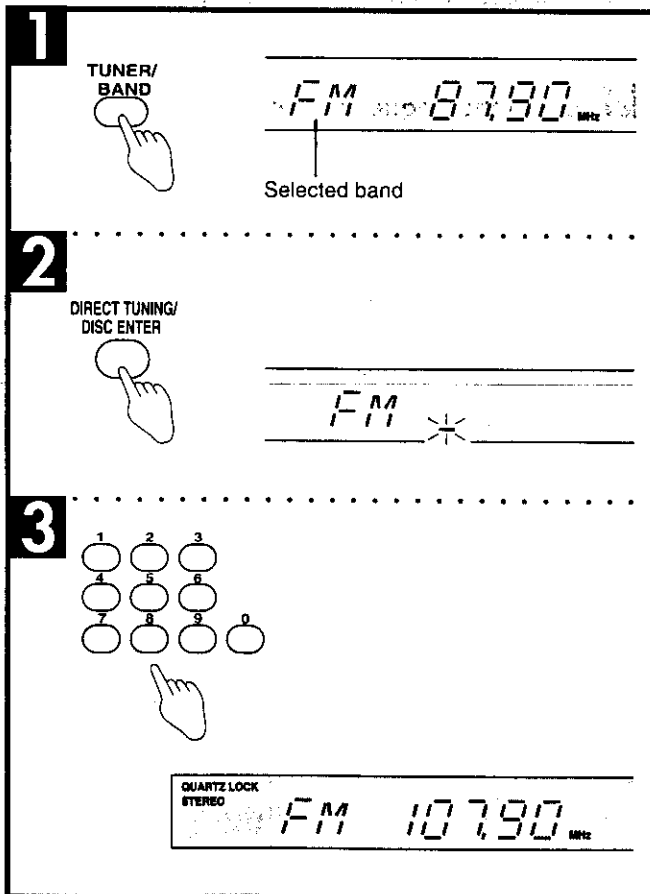

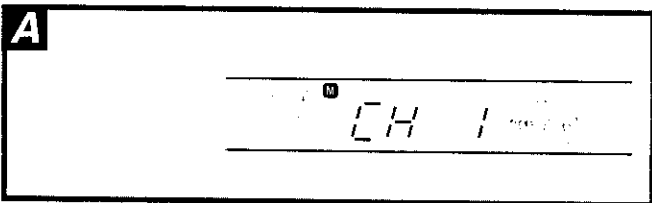
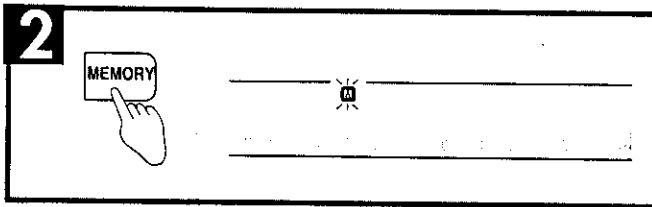
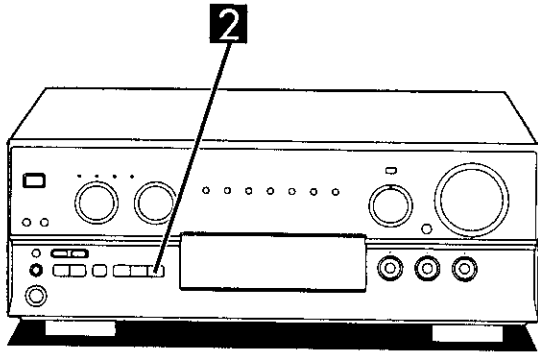

**Preset tuning**

Presetting radio stations into the memory channels of this unit makes selecting stations simple.

A total of 30 FM and AM stations can be preset.

**Please remember this**

If a new broadcast station is preset into a channel, the setting for the broadcast station which was previously entered in that channel will be automatically erased.

**Automatic memory presetting**

Automatic memory presetting allows this unit to automatically search for broadcast stations and then preset them into memory. With this method, the channels that can be preset into the memory are set as follows for different bands (FM or AM).

**When FM stations are preset,**

For FM stations ..... 1-30

**When FM and AM stations are preset,**

For FM stations ..... 1-20

For AM stations ..... 21-30

**1** Set to the frequency from which you want to start automatic memory presetting.  
(→ Page 20, 21.)

**2** Press [MEMORY] until the frequency begins to change.

(Automatic memory presetting will start.)

During automatic memory presetting, the memory indicator will flash while the frequency scrolls.

To stop, press [MEMORY] again.

**When a broadcast station is preset**

The memory indicator and the preset channel number will be displayed for approximately 1 second.

**When presetting is completed**

The last broadcast station to be preset will be displayed.

**Note**

Frequencies may not be preset correctly in cases where the broadcast waves are too strong or too weak. In such cases, carry out presetting manually. (→ Page 23.)

## Listening to radio broadcasts

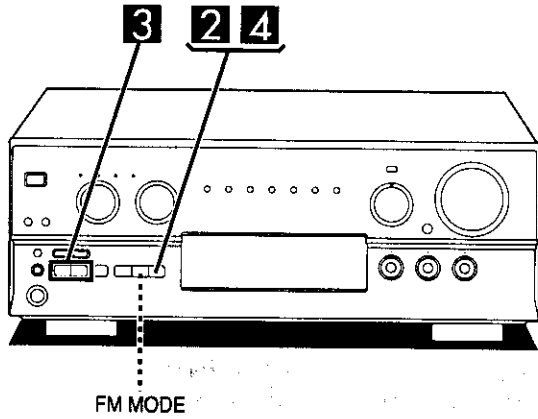

### Manual memory presetting

The desired stations can be preset into the desired channels by the user.

#### 1 Set to the desired frequency.

(→ Page 20, 21.)

If interference or static is keeping you from enjoying an FM broadcast, press [FM MODE] and change to monaural. You can preset the station in monaural just as in stereo.

#### 2 Press [MEMORY].

To cancel the memory function, press [MEMORY] again.

#### 3 Press [TUNING (∇ or ▲)] to select the desired channel.

Holding the buttons down lets you scroll through channels faster.

#### 4 Press [MEMORY].

The channel will blink on the display.

#### To continue presetting

Repeat steps 1 through 4.

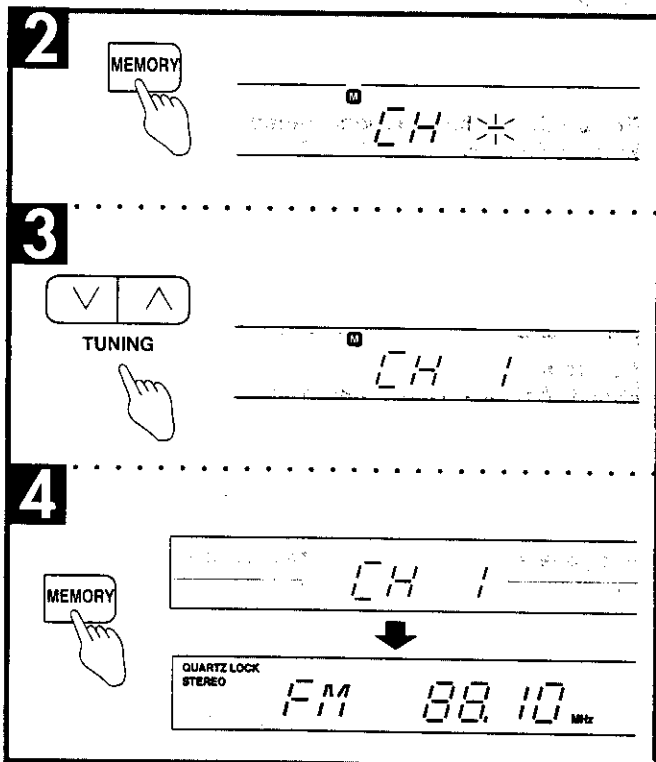

## Listening to radio broadcasts

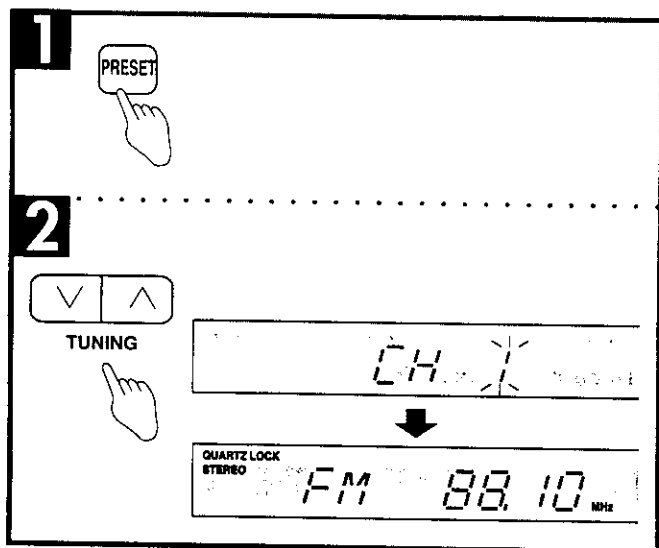
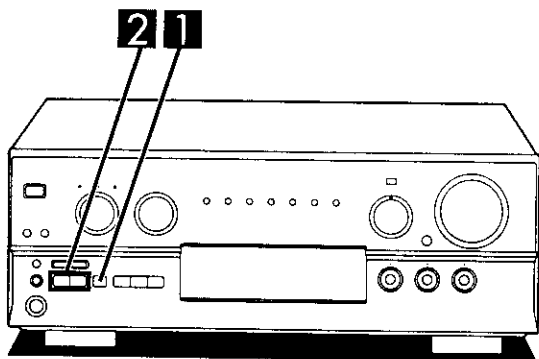

### To listen to preset channels

- 1 Press [PRESET].**
  - 2 Press [TUNING (∨ or ∧)].**  
Holding down the buttons lets you scroll through channels faster.
- The channel number will be changed for approximately 5 seconds.  
Select the desired channel number during that time.  
After 5 seconds, the display will change from the channel number to the frequency.

#### Note

If you press [PRESET] while the channel number is displayed, the display will change to the frequency.

### To confirm the channel number of the broadcast station being received

Press [PRESET].  
(The channel number flashes for approximately 5 seconds.)

#### Note

The channel number is not displayed if you change the frequency or FM mode setting.

### For your reference

Even if the power cord is disconnected from the household AC outlet, the memory will retain its contents for approximately one month.

### If frequency presettings are accidentally erased

Program the presettings once again.  
The power cord should remain connected for one hour or more for the memory back-up to be effective.



## Dolby Pro Logic

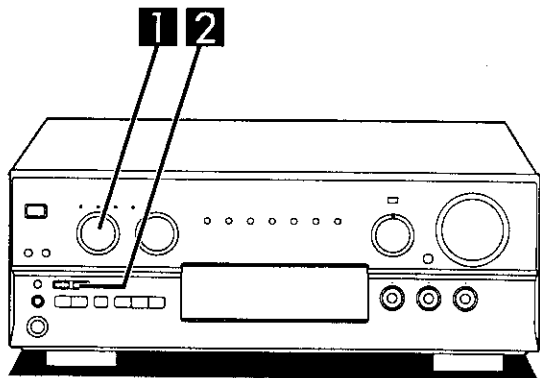

### Setting the center mode and adjusting speaker output level

- When ready to adjust speaker output level, situate yourself where you would normally be listening.
- First turn ON the speakers with [SPEAKERS A (or SPEAKERS)] on the receiver.
- If front speaker volume is unbalanced, adjust the balance with [BALANCE].

The following steps are for setting the output level of the front speakers and the center/surround speakers to the same listening level.

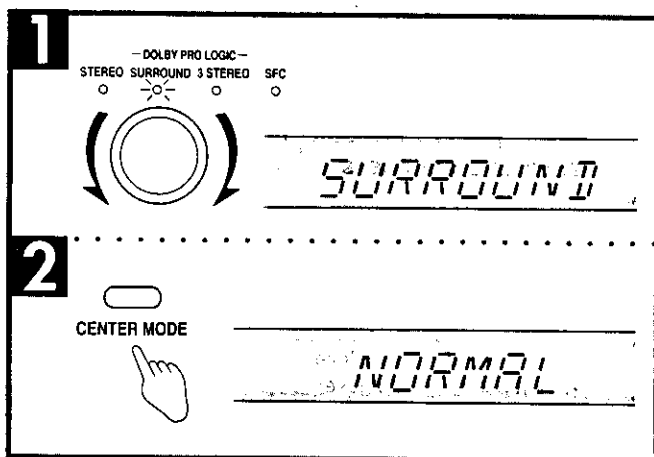

- 1 Turn the sound mode selector to select "SURROUND".

#### Note

1. Select "3 STEREO" if surround speakers have not been connected.
2. Remember you cannot adjust the output level of the surround speakers if you selected "3 STEREO" mode.

- 2 Press [CENTER MODE] to select the correct center mode.

When the button is pressed, the current center mode is displayed.

Pressing it again changes the center mode.

#### NORMAL

When the center speaker is smaller than the front speakers.

#### WIDEBAND

When the center speaker is the same size as or larger than the front speakers.

#### PHANTOM **SURROUND mode only**

When no center speaker is connected.

#### Note

In the PHANTOM mode, the sound which would have been sent to the center speaker will be divided equally between both the left and right front speakers.

(Continued on next page)

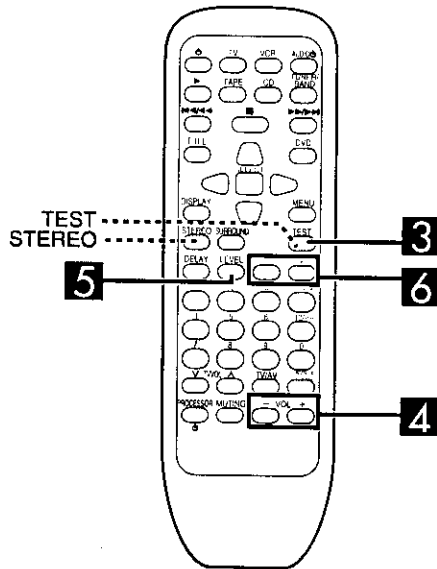

**3 by remote control only**

Press [TEST] to output a test signal.

The speaker outputting the test signal is displayed while the test is running.

- L : Front speaker (Left)
- C : Center speaker
- R : Front speaker (Right)
- S : Surround speakers

The subwoofer is muted while testing.

In the PHANTOM mode, the center speaker is OFF, so there is no center test signal and "C" is not displayed.

**4 by remote control**

Press [VOL (- or +)] to set the volume level normally used for enjoying the source.

**5 by remote control only**

Press [LEVEL] to select the center or surround speakers.

**6 by remote control only**

Press [-] or [+] to adjust the output level.

Adjust the output level of each speaker from the listening position until they are all identical.

-: Decrease the output level.

+: Increase the output level.

Output level can be varied within a range of -12 dB to +12 dB with front speaker output level serving as the zero point.

**Note**

During steps 5 and 6 above the test signal sequence is interrupted and the signal will only come from the selected speaker.

The sequence will resume when adjustments are stopped.

**To stop the test signal**

Press [TEST].

**To turn off the Dolby Pro Logic systems**

Press [STEREO].

**3**

TEST

TEST L

SURROUND mode

L-C-R-S

3 STEREO mode

L-C-R

**4**

- VOL +

**5**

LEVEL

5 0dB

Selected channel

**6**

- +

5 +3dB

Output level

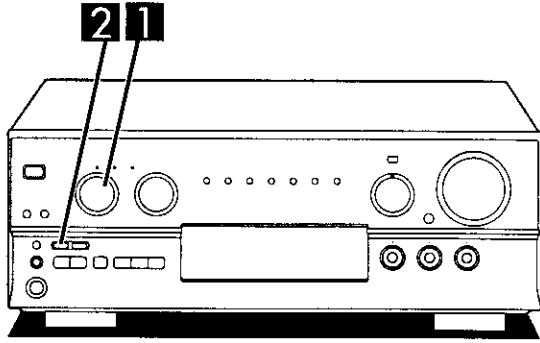

**Adjusting the delay time**

**When enjoying with SURROUND only**

Adjust the sound from the surround speakers until the proper effect is produced.

**1** Turn the sound mode selector to select "SURROUND".

**2** Press [DELAY TIME] to set the time.

When the button is pressed, the current delay time is displayed.

Each time the button is pressed, the delay time will increase by 5 ms within a range of 15 ms to 30 ms.

The standard setting is 20 ms.

**To calculate the delay time**

$D_1$ : Distance from front speakers  
 $D_2$ : Distance from surround speakers

- If  $D_1$  is equal to or less than  $D_2$   
 Set to 15 ms.
- If  $D_2$  is less than  $D_1$   
 Start at 15 ms and increase by 5 ms for every 1.5 m of difference between  $D_1$  and  $D_2$ .

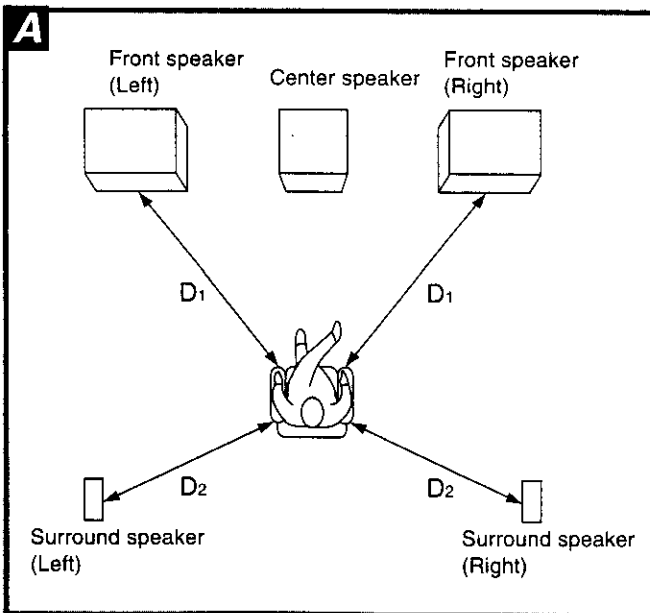
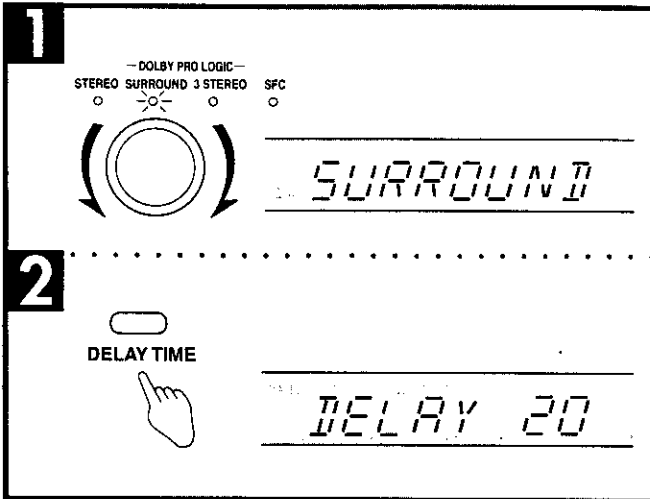

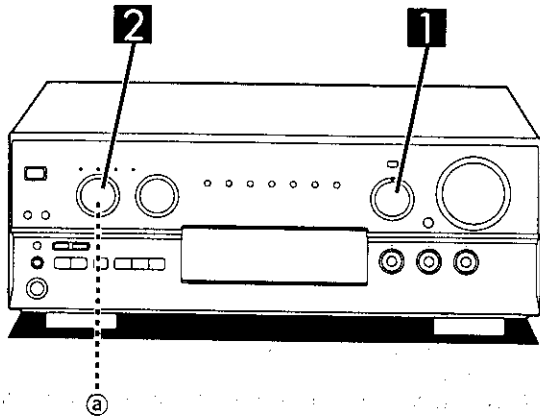

### Enjoying SURROUND or 3 STEREO

#### SA-AX730 only

Ensure the front speakers are connected to the A terminals and "SPEAKERS A" is selected.

**1** Turn [INPUT SELECTOR] to select and start the desired source.

**2** Turn the sound mode selector to select "SURROUND" or "3 STEREO".

#### Note

- When employing SURROUND, use software recorded in Dolby Surround.
- 3 STEREO can be used with stereo sources not encoded with Dolby Surround.

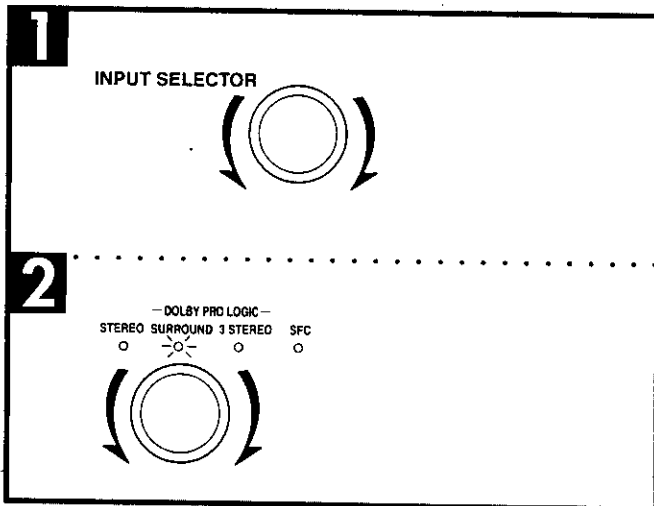

#### For your reference

You can set the Dolby Pro Logic mode for each source. Each source will retain the selected mode.

#### To turn off the Dolby Pro Logic systems

Turn the sound mode selector (@) to select "STEREO".

#### Note (SA-AX730 only)

These modes cannot be turned on while "SPEAKERS B" is on. These modes will also be automatically canceled and the modes in the memory for all sources will be cleared. The modes must be selected again for all sources when SPEAKERS B is turned off again.

Manufactured under license from Dolby Laboratories Licensing Corporation.  
DOLBY, the double-D symbol  and "PRO LOGIC" are trademarks of Dolby Laboratories Licensing Corporation.

## SFC (Sound Field Control)

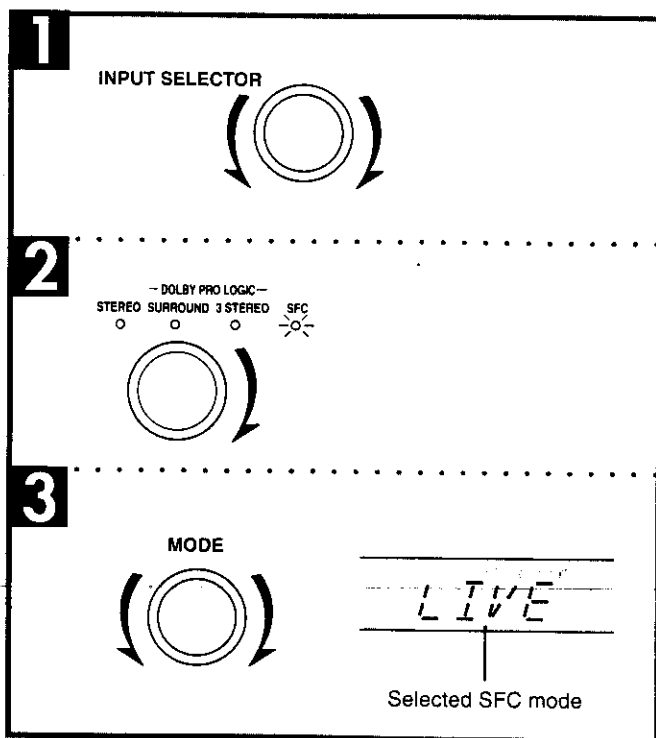
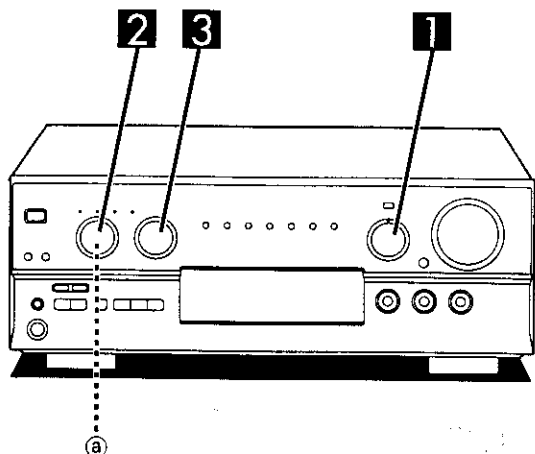

The SFC function gives presence and spread thereby enhancing and enriching the music or movie. Read the following explanations in order to better understand how to make your selection.

**Note**

The center speaker is not used in the hall, and simulated modes.

**HALL**

This mode imparts a reflection and spread which will make you feel as if you are in a large concert hall.

**CLUB**

Like a jazz club, this mode provides an exciting and intimate atmosphere. It simulates the sound field of a relatively small room having a low ceiling and hard reflective surfaces, for a "live" sound with enhanced presence to bring the performers up close.

**LIVE**

Primarily for vocal pieces, this mode adds gloss to the vocals and you'll feel as though you were hearing a live stage performance.

**THEATER**

You can clearly perceive the directions and source of the movie. Real ambience of sound can also be recreated naturally using this mode.

THEATER mode can be used with stereo sources not encoded with Dolby Surround.

**Note**

When using Dolby Surround encoded materials, select "SURROUND".

**SIMULATED (SIM SURR)**

Choose this mode if little or no sound will be heard from the surround speakers.

You can feel as if you were in a more expanded space adding to the actual sound from the source.

This mode also adds effect to monaural sources by outputting sound from surround speakers.

**SA-AX730 only**

Ensure the front speakers are connected to the A terminals and "SPEAKERS A" is selected.

**1** Turn [INPUT SELECTOR] to select and start the desired source.

**2** Turn the sound mode selector to select "SFC".

**3** Turn [MODE] to select the desired SFC mode.

**Note**

The SFC mode can also be selected by directly turning [MODE] in step 2 instead of selecting "SFC".

**For your reference**

You can set the SFC mode for each source. Each source will retain the selected mode.

**To turn off the SFC function**

Turn the sound mode selector (ⓐ) to select "STEREO".

**Note (SA-AX730 only)**

These modes cannot be turned on while "SPEAKERS B" is on. These modes will also be automatically canceled and the modes in the memory for all sources will be cleared. The modes must be selected again for all sources when SPEAKERS B is turned off again.

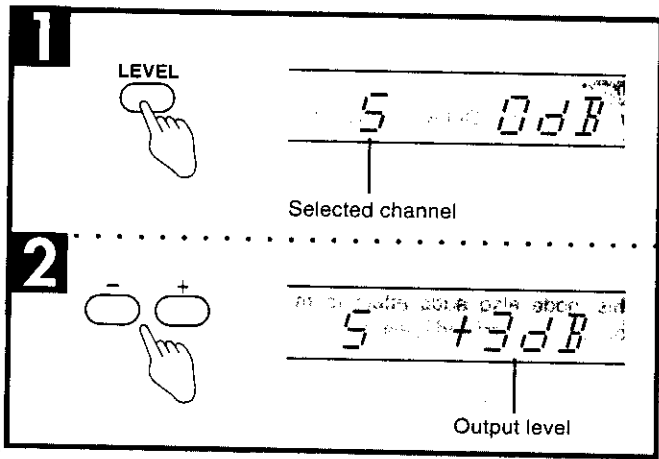
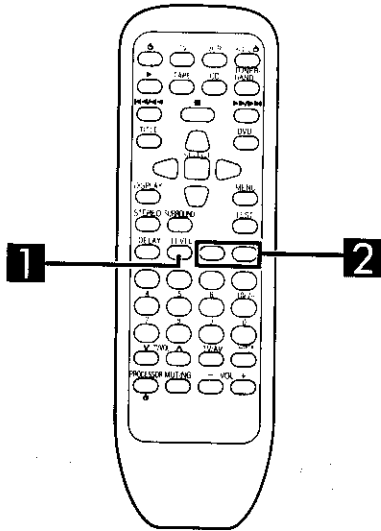
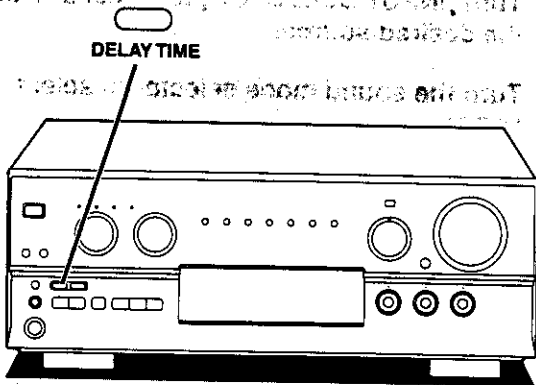
**A****B****SFC (Sound Field Control)****Adjusting field of sound**

With this unit, you can adjust speaker volume.  
Adjust the field of sound while listening to a source.

**To adjust the volume of the center and surround speakers** **A**  
by remote control only

**1** Press [LEVEL] to select the center or surround speakers.

**Note**

You can adjust the center speaker volume only in the theater mode.

**2** Press [+] or [-] to adjust the output level.

**To adjust the delay time** **B**

**Press [DELAY TIME] to set the time.**

When the button is pressed, the current delay time is displayed.  
Each time the button is pressed, the delay time will change.

The delay time increments are different depending on the SFC mode.

Select a delay time setting to accommodate to your individual needs.

SFC modes	Available delay time setting (ms)
HALL	20, 25, 30, <b>40</b> , 50
CLUB	0, <b>15</b> , 20, 25, 30
LIVE	15, 20, 30, 40, <b>50</b>
THEATER	15, <b>20</b> , 25, 30, 40
SIMULATED	<b>15</b> , 20, 25, 30, 40

The figures in bold italics are the factory settings.

## DVD 6CH INPUT mode

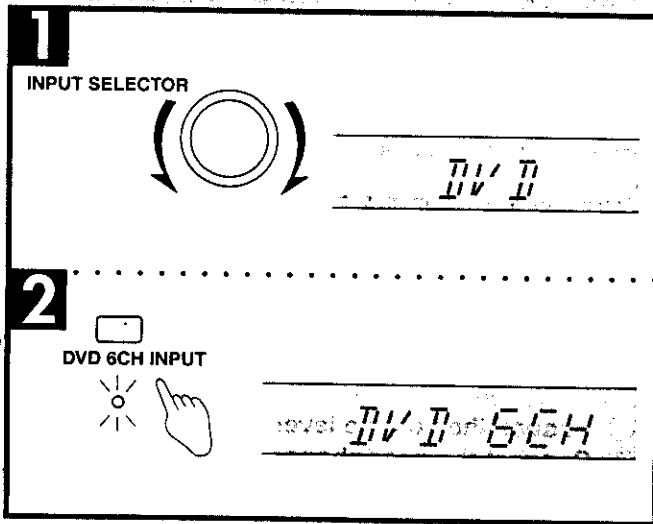
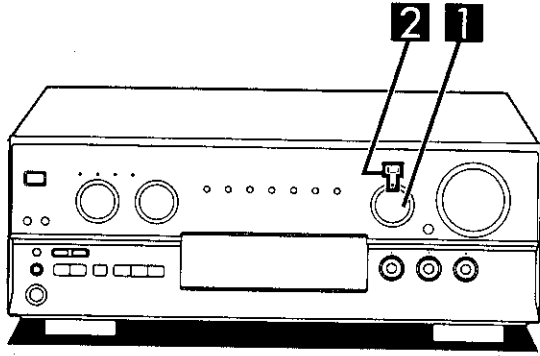

Use this mode when playing back 6 channel discrete sources such as Dolby Digital. To use this mode connect a DVD player, digital surround processor or any other component that has 6 channel discrete output capabilities (➔ Page 9, 11).

Dolby Digital and other 6 channel discrete sources are recorded with each speaker channel discrete from the other. Depth, movement, position and other characteristics are maintained, so using this mode will make you feel as if you were at the movie theater when in your own home.

### Note

In the DVD 6CH INPUT mode, if sound is not produced from the center speaker, surround speakers or subwoofer, check speaker setup of the DVD player or digital sound processor connected to the receiver.

### SA-AX730 only

Ensure the front speakers are connected to the A terminals and "SPEAKERS A" is selected.

**1** Turn [INPUT SELECTOR] to select "DVD".

**2** Press [DVD 6CH INPUT] to select "DVD 6CH".  
Changes as follows, each time the button is pressed.  
DVD 6CH ⇌ DVD (2CH)

The "DVD 6CH INPUT" indicator lights when "DVD 6CH" is selected.

If you press this button while another source (CD, PHONO, etc.) is selected, the receiver switches the source to DVD and engages the DVD 6CH INPUT mode.

**3** Start the desired source.

Follow your equipment's operating instructions.

### Note

You cannot select Dolby Pro Logic mode while in the DVD 6CH INPUT mode.

### Note (SA-AX730 only)

This mode cannot be turned on while "SPEAKERS B" is on. This mode will also be automatically canceled and the modes in the memory for all sources will be cleared. The modes must be selected again for all sources when SPEAKERS B is turned off again.

Surround mode

## Other functions

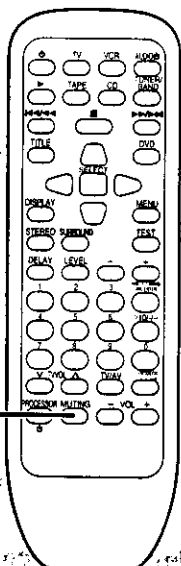
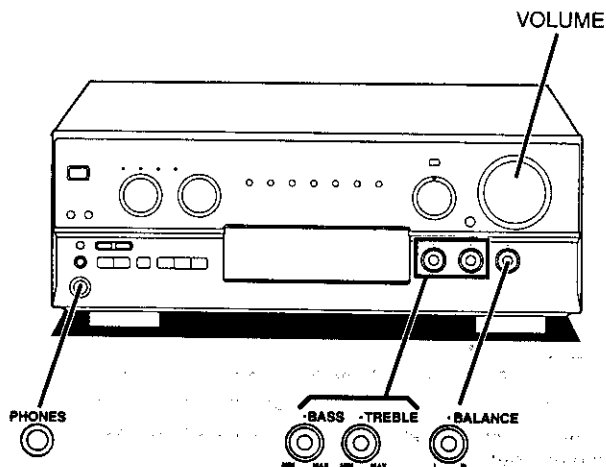

### To adjust the tone quality **A**

Turn [BASS] to adjust the low frequency sound.

Turn [TREBLE] to adjust the high frequency sound.

### To adjust the sound balance **B**

Turn [BALANCE] to adjust the left/right sound balance.

### To mute the sound level **C**

by remote control only

Press [MUTING].

The message "MUTING ON NOW" runs repeatedly from right to left across the display as long as the muting function is on.

Press once again to return to the previous volume level.

#### Note

Muting is cancelled when the unit is turned off.

### To listen through headphones **D**

- ① Reduce the volume level.
- ② Connect the headphones.  
Plug type: 6.3 mm stereo
- ③ Adjust the volume level.

Turn the speakers off when using headphones. Turning the speakers off automatically engages STEREO mode and ensures no sound is heard from the subwoofer. If either SURROUND or 3 STEREO is used, the sound heard through the headphones will seem unusual.

#### Note

Avoid listening for prolonged periods of time to prevent hearing damage.

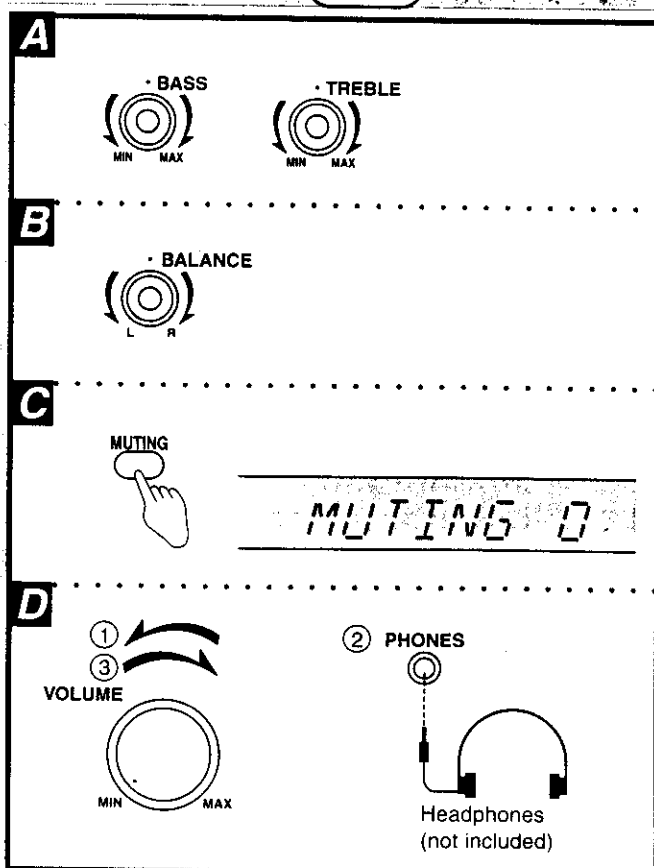



## Making a recording

**A**

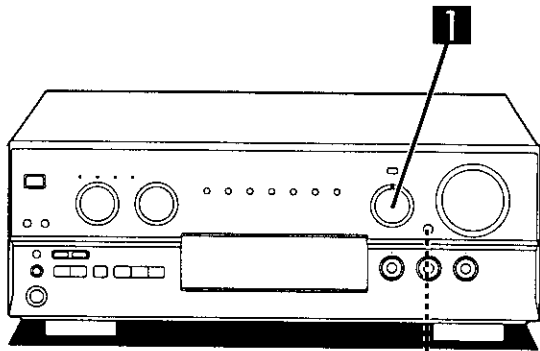

TAPE MONITOR :

**1**

INPUT SELECTOR



**B**

TAPE MONITOR



**C**

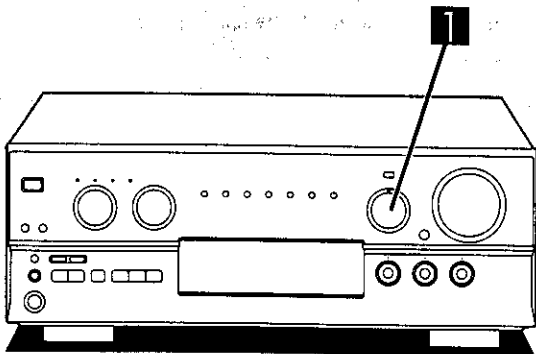

**1**

INPUT SELECTOR



### Recording on a tape deck **A**

Before recording, prepare the tape deck for recording. See the tape deck's operating instructions for details.

**1** Turn [INPUT SELECTOR] to select the source to be recorded.

Any source can be selected except TAPE.

**2** Begin recording on the tape deck. Follow your tape deck's operating instructions.

**3** Begin the source to be recorded. Follow your equipment's operating instructions.

### To monitor the recorded sound **B**

It is possible to check the sound being recorded if your tape deck is a 3 head system.

Press [TAPE MONITOR] on this unit and set the monitor button on the tape deck to "TAPE".

Press [TAPE MONITOR] once again to turn it off.

### Recording on a VCR **C**

Before recording, prepare VCR for recording. See the VCR's operating instructions for details.

**1** Turn [INPUT SELECTOR] to select the source to be recorded.

Any source can be selected except VCR and TAPE.

#### Note

Recording from the tape deck is not possible.

**2** Begin recording on the VCR. Follow your VCR's operating instructions.

**3** Begin the source to be recorded. Follow your equipment's operating instructions.

#### Note

When you select DVD 6CH INPUT mode, only sound from the front left and right speakers is recorded.

#### To record all 6 channels

Set the playback mode on your DVD player or digital surround processor to 2 channel (stereo) mode.

For details, see the instruction manual that came with the connected equipment.

Other Functions Recording

## Timer function

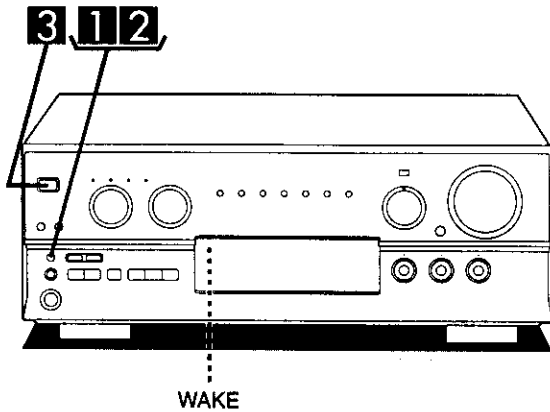

There are two timer functions: the sleep timer and the wake timer.

- **Sleep timer:**  
The unit turns off after a set time.  
It can be set for 30, 60, or 90 minutes.
- **Wake timer:**  
The unit can be set to turn on a certain number of hours after it is turned off.  
It can be set for 5, 7, or 9 hours.

### Setting the timers

- 1 Press [TIMER] to select the desired timer mode.

The timer mode changes as follows:  
SLEEP → WAKE → OFF

- 2 [Within 5 seconds] Press [TIMER] and release when the time you require is displayed.

The display changes as follows:

- In sleep timer mode  
30 → 60 → 90 (minutes)

- In wake timer mode  
5H → 7H → 9H (hours)

The frequency is displayed again 5 seconds after the setting is completed.

- 3 **Wake timer mode only**  
Press [⏻/⏻] to turn off the unit.  
The "WAKE" indicator lights up.

### Checking the remaining time on the sleep timer and the time set for the wake timer

Press [TIMER] once.

#### Note

Do not press [TIMER] again before the remaining time indication goes out.

The setting may change if you do this.

### Changing a setting

Repeat steps 1 and 2.

### To cancel the timer

Press [TIMER] until "OFF" is displayed.  
"SLEEP" or "WAKE" will go out.

#### Note

- The timers cannot be used together.
- The sleep timer turns off the receiver, and the wake timer turns on the receiver, but they do not turn off/on any externally connected components.

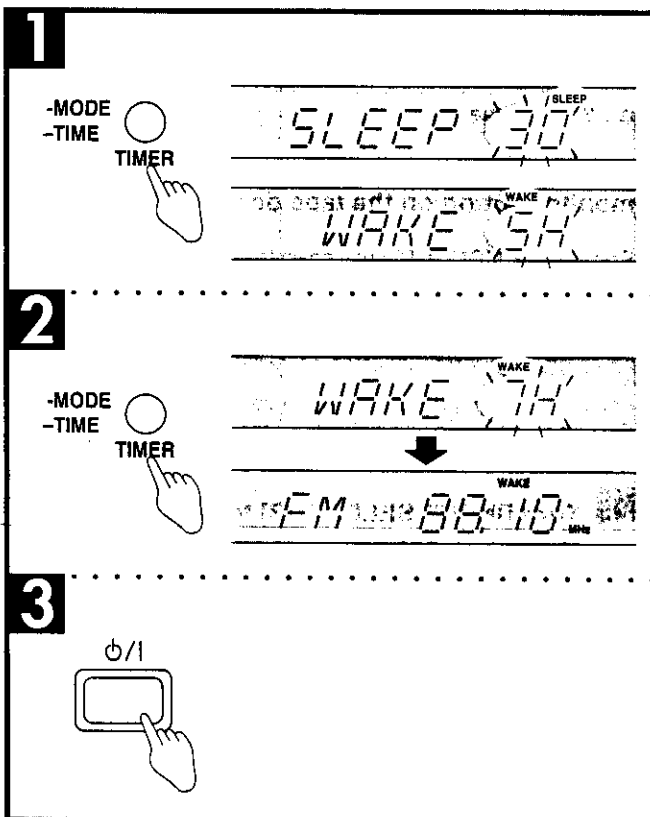

## About the HELP function

SA-AX730 only

A

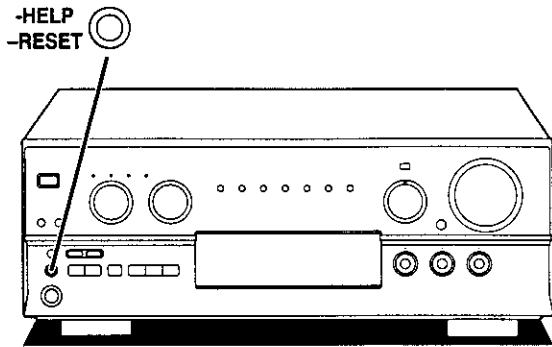

If you make a mistake in operation or if sound output stops due to some operation which was performed, the HELP function displays information which can be useful for indicating the method by which this condition can be remedied.

If "ERROR" or scrolling characters (for instance, "SPEAKER OFF NOW") appear on the display during operation, carry out the following operation.

### Press [-HELP, -RESET].

The method for remedying this situation will be displayed.

### For your reference

If the above button is pressed for 2 seconds or more until "RESET" appears on the display, the operation settings for the unit will be initialized to the settings made at the time of shipment.

Any broadcasting stations which have been preset into memory will not be erased at this time.

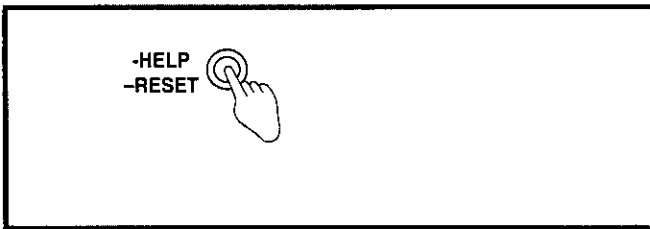

## Maintenance

### If the surfaces are dirty

To clean this unit, wipe with a soft, dry cloth.

If the surfaces are extremely dirty, use a soft cloth dipped in a soap-and-water solution or a weak detergent solution.

- Never use alcohol, paint thinner or benzine to clean this unit.
- Before using chemically impregnated cloth, read the instructions that came with the cloth carefully.

## Troubleshooting guide

Before requesting service for this unit, check the chart below for a possible cause of the problem you are experiencing. Some simple checks or a minor adjustment on your part may eliminate the problem and restore proper operation.

If you are in doubt about some of the check points, or if the remedies indicated in the chart do not solve the problem, refer to the directory of Authorized Service Centers (enclosed with this unit) to locate a convenient service center, or consult your dealer for instructions.

Problem	Probable cause(s)	Suggested remedy	Page(s)
<b>While listening to FM broadcasts</b>			
Hiss heard during stereo broadcasts, but not during monaural ones.	Modulation for the two types is different so some noise may be heard during stereo broadcasts.	<ul style="list-style-type: none"> <li>• Reduce the treble.</li> <li>• Change the location and direction of the antenna.</li> </ul>	32 12, 13, 14
Excessive noise in both stereo and monaural broadcasts.	Antenna location and direction poor.	<ul style="list-style-type: none"> <li>• Use an outdoor antenna.</li> <li>• Use an antenna with more elements.</li> </ul>	13, 14
	Station is distant.		-
STEREO and QUARTZ LOCK indicators flicker.	Antenna location and direction poor.	<ul style="list-style-type: none"> <li>• Change the location and direction of the antenna.</li> <li>• Use an outdoor antenna.</li> <li>• Use an antenna with more elements.</li> </ul>	12, 13, 14
	Station is distant.		13, 14
Stereo broadcasts highly distorted.	Building or mountain nearby.	<ul style="list-style-type: none"> <li>• Use an antenna with more elements.</li> </ul>	-

<b>While listening to AM broadcasts</b>			
Unusual "beat" sound.	A television is on nearby.	<ul style="list-style-type: none"> <li>• Separate the two or turn the television off.</li> </ul>	-
	Adjacent signal is interfering.	<ul style="list-style-type: none"> <li>• Reduce the treble.</li> </ul>	32
Low-pitched "hum" heard when a station is tuned.	Power cord is near the antenna wires.	<ul style="list-style-type: none"> <li>• Separate the power cord from the wires.</li> </ul>	-
	Electronic interference from a power cord.	<ul style="list-style-type: none"> <li>• Use an outdoor antenna.</li> </ul>	13, 14
A continuous or intermittent hiss is heard.	Interference from other appliances.	<ul style="list-style-type: none"> <li>• Separate this unit from such appliances.</li> </ul>	-
An AM broadcast station cannot be picked up clearly.	Frequency steps is set to 10 kHz.	<ul style="list-style-type: none"> <li>• Hold down [BAND] for about 3 seconds. this will changes frequency step to 9 kHz.</li> </ul>	20

<b>Common Problems</b>			
Unit doesn't come on.	The power cord plug is not fully inserted.	<ul style="list-style-type: none"> <li>• Confirm the plug is fully inserted.</li> </ul>	-
Sound is not heard.	The speaker indicators are off.	<ul style="list-style-type: none"> <li>• Turn on the speaker indicators.</li> </ul>	18
	The tape monitor function is on.	<ul style="list-style-type: none"> <li>• Press the tape monitor button.</li> </ul>	19
	The muting function is on.	<ul style="list-style-type: none"> <li>• Press the muting button on the remote control.</li> </ul>	32
	Incomplete or incorrect connection to speakers and external equipment.	<ul style="list-style-type: none"> <li>• Check all connections.</li> </ul>	8, 9, 10, 11 15, 16, 17
	The incorrect input source has been selected.	<ul style="list-style-type: none"> <li>• Select the correct source.</li> </ul>	18
Sound suddenly stops or none is heard when the unit is switched on. "OVERLOAD" appears on the display.	The protection circuitry has functioned because: the positive and negative speakers wires have shorted; speakers with a lower impedance than this unit's rated impedance are being used; the speakers are under strain through excessive volume, excessive power, or by being used in a high temperature environment.	<ul style="list-style-type: none"> <li>• Switch off the unit, determine and correct the cause, then switch the unit on.</li> <li>• Use speakers with the right impedance rating.</li> </ul>	- 16, 17

## Technical specifications (DIN 45 500) (SA-AX730)

### ■ AMPLIFIER SECTION

<b>Power output</b> (at 240 V for Australia and N.Z.) (at 127 V for others)	
DIN 1 kHz (T. H. D. 1%)	2 x 100 W (6 Ω)
20 Hz - 20 kHz continuous power output both channels driven	2 x 80 W (6 Ω)
<b>Total harmonic distortion</b>	
rated power at 20 Hz - 20 kHz	0.05% (6 Ω)
half power at 1 kHz	0.03% (6 Ω)
<b>Power output at the Dolby Pro Logic operation</b>	
DIN 1 kHz (T. H. D. 1%)	
Front (For Australia and N.Z.)	2 x 100 W (6 Ω)
(For others)	2 x 85 W (6 Ω)
Center (For Australia and N.Z.)	2 x 100 W (6 Ω)
(For others)	85 W (6 Ω)
Surround (For Australia and N.Z.)	2 x 100 W (6 Ω)
(For others)	2 x 85 W (6 Ω)
<b>Power bandwidth</b>	
both channels driven, -3 dB	10 Hz - 40 kHz (6 Ω)
<b>Damping factor</b>	30 (6 Ω)
<b>Load impedance</b>	
Front	
A or B	4 - 16 Ω
A and B	8 - 16 Ω
Center	6 - 16 Ω
Surround	6 - 16 Ω
<b>Frequency response</b>	
PHONO RIAA standard curve (30 Hz - 15 kHz) ± 0.8 dB	
CD, TAPE, DVD, TV, VCR	10 Hz - 40 kHz, ± 3 dB
<b>Input sensitivity and impedance</b>	
PHONO	3 mV/47 kΩ
CD, TAPE, DVD, TV, VCR	200 mV/22 kΩ
<b>S/N at rated power (6 Ω)</b>	
PHONO	70 dB (IHF, A: 80 dB)
CD, TAPE, DVD, TV, VCR	75 dB (IHF, A: 85 dB)
<b>Tone controls</b>	
BASS	50 Hz, +10 to -10 dB
TREBLE	20 kHz, +10 to -10 dB
<b>Output voltage</b>	
TAPE REC (OUT), VCR OUT	200 mV
Channel balance (250 Hz - 6.3 kHz)	± 1 dB
Channel separation	55 dB
Headphones output level and impedance	430 mV/330 Ω
Subwoofer frequency response	7 - 100 Hz, ±3 dB

### ■ FM TUNER SECTION

<b>Frequency range</b>	87.50 - 108.00 MHz
<b>Sensitivity</b>	
S/N 30 dB	1.5 μV/75 Ω
S/N 26 dB	1.3 μV/75 Ω
S/N 20 dB	1.2 μV/75 Ω
IHF usable sensitivity (IHF'58)	1.5 μV/75 Ω
IHF 46 dB stereo quieting sensitivity	22 μV/75 Ω
<b>Total harmonic distortion</b>	
MONO	0.2%
STEREO	0.3%

### S/N

MONO	60 dB (73 dB, IHF)
STEREO	58 dB (67 dB, IHF)
<b>Frequency response</b>	
20 Hz-15 kHz	+1 dB, -2 dB
<b>Alternate channel selectivity</b>	
± 400 kHz	65 dB
<b>Capture ratio</b>	1.5 dB
<b>Image rejection at 98 MHz</b>	40 dB
<b>IF rejection at 98 MHz</b>	70 dB
<b>Spurious response rejection at 98 MHz</b>	70 dB
<b>AM suppression</b>	50 dB
<b>Stereo separation</b>	
1 kHz	40 dB
<b>Carrier leak</b>	
19 kHz	-30 dB (-35 dB, IHF)
38 kHz	-50 dB (-55 dB, IHF)
<b>Channel balance (250 Hz - 6.3 kHz)</b>	± 1.5 dB
<b>Limiting point</b>	1.2 μV
<b>Bandwidth</b>	
IF amplifier	180 kHz
FM demodulator	1000 kHz
<b>Antenna terminal</b>	75 Ω (unbalanced)

### ■ AM TUNER SECTION

<b>Frequency range</b>	
AM	522 - 1611 kHz (9 kHz steps) 530 - 1620 kHz (10 kHz steps)
<b>Sensitivity</b>	20 μV, 330 μV/m
<b>Selectivity (at 999 kHz)</b>	55 dB
<b>IF rejection (at 999 kHz)</b>	50 dB

### ■ VIDEO SECTION

<b>Output voltage at 1 V input (unbalanced)</b>	1 ± 0.1 Vp-p
<b>Maximum input voltage</b>	1.5 Vp-p
<b>Input/output impedance</b>	75 Ω (unbalanced)

### ■ GENERAL

<b>Power supply</b>	
For Australia and N.Z.	AC 230-240 V, 50 Hz
For others	AC 110-127 V/220-240 V, 50/60 Hz
<b>Power consumption</b>	240 W
<b>Dimensions (W x H x D)</b>	430 x 158 x 324.5 mm
<b>Weight</b>	9.7 kg

### Power consumption in standby mode 3 W

#### Notes:

- Specifications are subject to change without notice. Weight and dimensions are approximate.
- Total harmonic distortion is measured by the digital spectrum analyzer.

**AMPLIFIER SECTION**

<b>Power output</b> (at 240 V for Australia and N.Z.) (at 127 V for others)	
DIN 1 kHz (T. H. D. 1%)	2 x 60 W (6 Ω)
40 Hz - 20 kHz continuous power output both channels driven	2 x 40 W (6 Ω)
<b>Total harmonic distortion</b>	
rated power at 40 Hz - 20 kHz	0.8% (6 Ω)
half power at 1 kHz	0.07% (6 Ω)
<b>Power output at the Dolby Pro Logic operation</b>	
DIN 1 kHz (T. H. D. 1%)	
Front	2 x 60 W (6 Ω)
Center	60 W (6 Ω)
Surround	2 x 60 W (6 Ω)
<b>Power bandwidth</b>	
both channels driven, -3 dB	10 Hz - 40 kHz (6 Ω)
<b>Damping factor</b>	30 (6 Ω)
<b>Load impedance</b>	
Front	4 - 16 Ω
Center	6 - 16 Ω
Surround	6 - 16 Ω
<b>Frequency response</b>	
PHONO RIAA standard curve (30 Hz - 15 kHz) ± 0.8 dB	
CD, TAPE, TV, DVD, VCR	10 Hz - 40 kHz, ± 3 dB
<b>Input sensitivity and impedance</b>	
PHONO	3 mV/47 kΩ
CD, TAPE, TV, DVD, VCR	200 mV/22 kΩ
<b>S/N at rated power (6 Ω)</b>	
PHONO	70 dB (IHF, A: 80 dB)
CD, TAPE, TV, DVD, VCR	75 dB (IHF, A: 85 dB)
<b>Tone controls</b>	
BASS	50 Hz, +10 to -10 dB
TREBLE	20 kHz, +10 to -10 dB
<b>Output voltage</b>	
TAPE REC (OUT), VCR OUT	200 mV
<b>Channel balance (250 Hz - 6.3 kHz)</b>	± 1 dB
<b>Channel separation</b>	55 dB
<b>Headphones output level and impedance</b>	430 mV/330 Ω
<b>Subwoofer frequency response</b>	7 - 100 Hz, ±3 dB

**FM TUNER SECTION**

<b>Frequency range</b>	87.50 - 108.00 MHz
<b>Sensitivity</b>	
S/N 30 dB	1.5 μV/75 Ω
S/N 26 dB	1.3 μV/75 Ω
S/N 20 dB	1.2 μV/75 Ω
<b>IHF usable sensitivity (IHF'58)</b>	1.5 μV/75 Ω
<b>IHF 46 dB stereo quieting sensitivity</b>	22 μV/75 Ω
<b>Total harmonic distortion</b>	
MONO	0.2%
STEREO	0.3%

**S/N**

MONO	60 dB (73 dB, IHF)
STEREO	58 dB (67 dB, IHF)
<b>Frequency response</b>	
20 Hz-15 kHz	+1 dB, -2 dB
<b>Alternate channel selectivity</b>	
± 400 kHz	65 dB
<b>Capture ratio</b>	1.5 dB
<b>Image rejection at 98 MHz</b>	40 dB
<b>IF rejection at 98 MHz</b>	70 dB
<b>Spurious response rejection at 98 MHz</b>	70 dB
<b>AM suppression</b>	50 dB
<b>Stereo separation</b>	
1 kHz	40 dB
<b>Carrier leak</b>	
19 kHz	-30 dB (-35 dB, IHF)
38 kHz	-50 dB (-55 dB, IHF)
<b>Channel balance (250 Hz - 6.3 kHz)</b>	± 1.5 dB
<b>Limiting point</b>	1.2 μV
<b>Bandwidth</b>	
IF amplifier	180 kHz
FM demodulator	1000 kHz
<b>Antenna terminal</b>	75 Ω (unbalanced)

**AM TUNER SECTION**

<b>Frequency range</b>	522 - 1611 kHz (9 kHz steps) 530 - 1620 kHz (10 kHz steps)
<b>Sensitivity</b>	20 μV, 330 μV/m
<b>Selectivity (at 999 kHz)</b>	55 dB
<b>IF rejection (at 999 kHz)</b>	50 dB

**VIDEO SECTION**

<b>Output voltage at 1 V input (unbalanced)</b>	1 ± 0.1 Vp-p
<b>Maximum input voltage</b>	1.5 Vp-p
<b>Input/output impedance</b>	75 Ω (unbalanced)

**GENERAL**

<b>Power supply</b>	
For Australia and N.Z.	AC 230-240 V, 50 Hz
For others	AC 110-127 V/220-240 V, 50/60 Hz
<b>Power consumption</b>	
For Australia and N.Z.	230 W
For others	240 W
<b>Dimensions (W x H x D)</b>	430 x 136 x 320.6 mm
<b>Weight</b>	
For Australia and N.Z.	8.5 kg
For others	9.3 kg

**Power consumption in standby mode 2 W**

**Notes:**

- Specifications are subject to change without notice. Weight and dimensions are approximate.
- Total harmonic distortion is measured by the digital spectrum analyzer.